

TEC-EL-04103
SPIDER REV-0 TECHNICAL MANUAL

Electronic Development Department
Bluberi Gaming Canada Inc.



Document Revisions

Version	Date	Change	Author
V0.1	04/22/2017	<ul style="list-style-type: none">• First Draft	Y.P.
V0.2	01/31/2018	<ul style="list-style-type: none">• Updated Enclosure Design• Updated Block Diagram	Y.P.

Contents

TOPIC	4
BOARD DIMENSIONS	5
BLOCK DIAGRAM	7
GENERAL DESCRIPTION	8
PROCESSOR AND MEMORY	10
BIOS	11
SECURITY	12
SOUND AND VIDEO	13
INPUTS AND OUTPUTS	14
EDGE CONNECTOR	14
EXPANSION DRAWER CONNECTOR	16
FRONT PANEL CONNECTIONS	17
CCTALK.....	22
MISCELLANEOUS	23
CONTACT US	25

Topic

This document provides technical information and specifications for the SPIDER Rev-0 gaming board.



Board Dimensions

With Enclosure

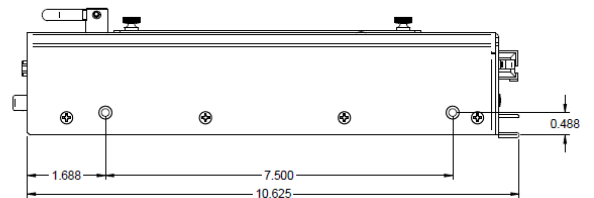
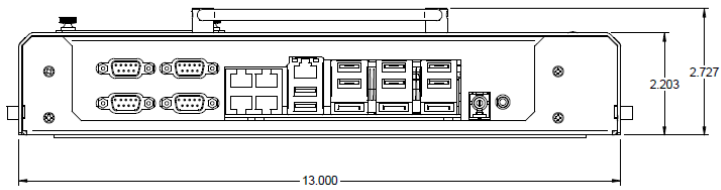
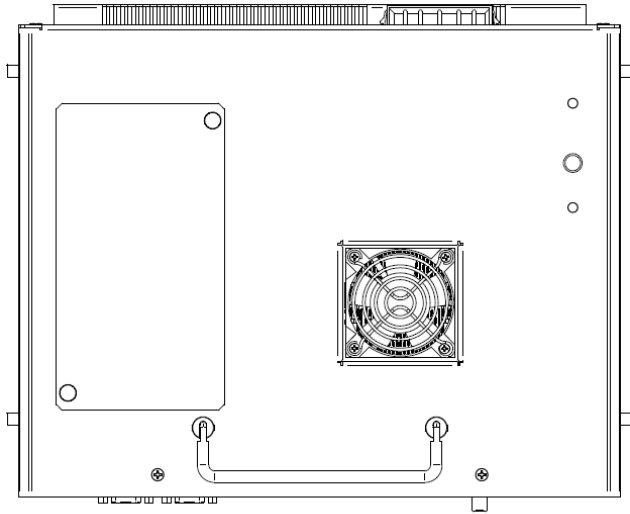

Without Enclosure

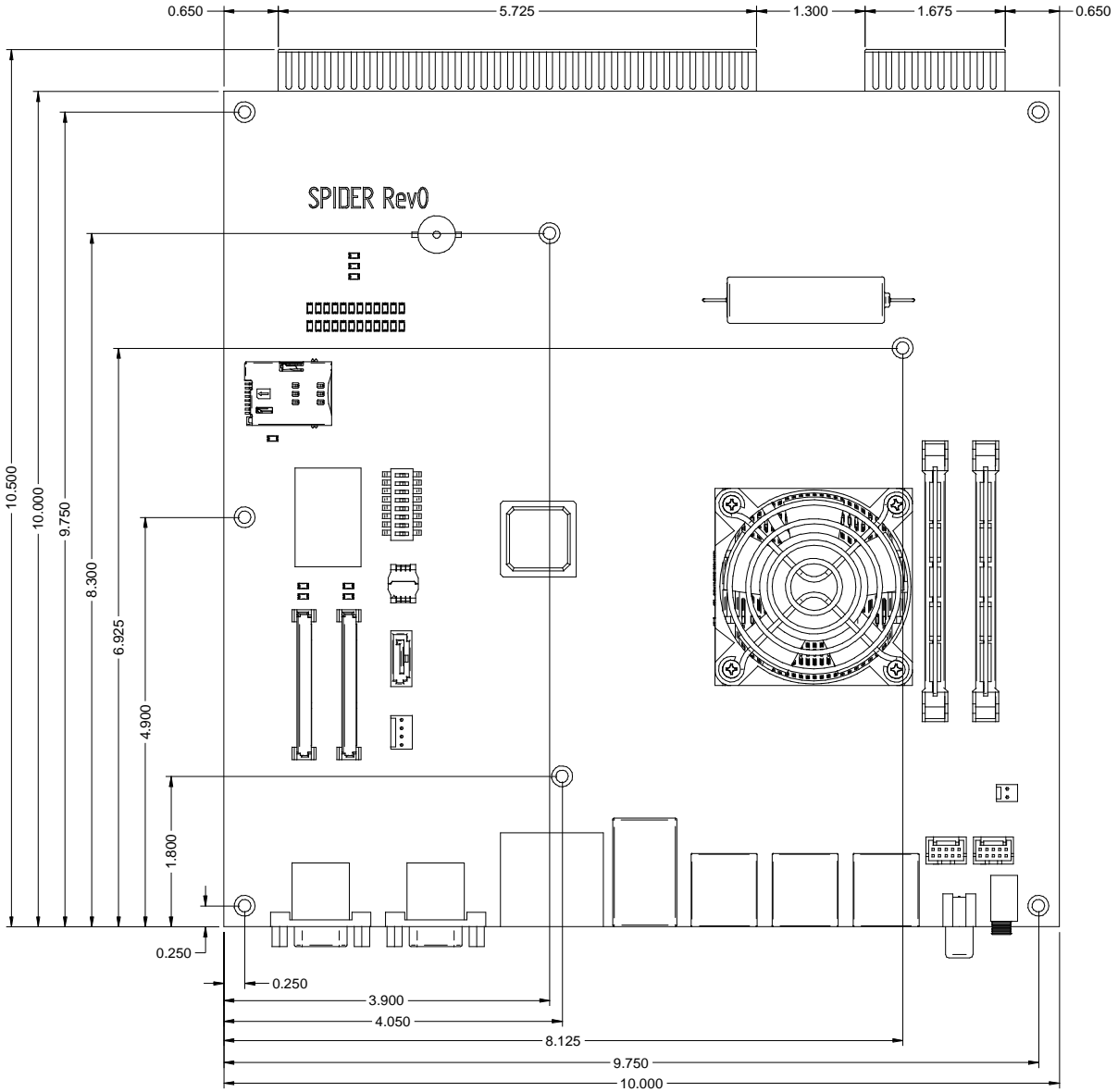

Block Diagram

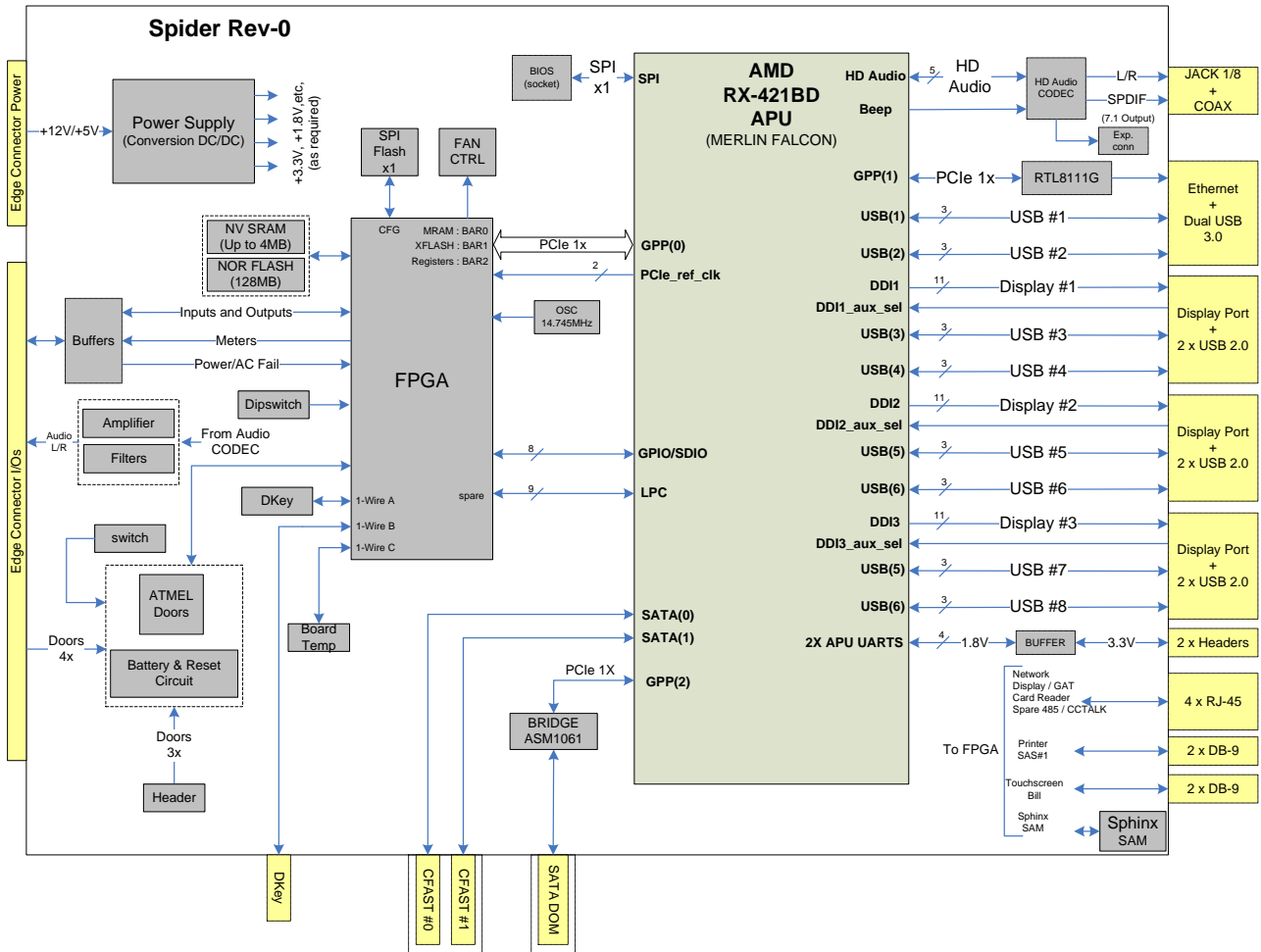

General Description

Chipset

- AMD embedded APU Merlin Falcon R-Series RX-421BD (Excavator Quad cores, 2.1-3.4GHz, R7 GPU with 8x GCN cores @ 800MHz, 12-35W TDP).

Display

- 3x Digital Display Interface (DDI) on Display Port connector. Each DDI support the Dual-Mode Implementation (also called DP++). This feature gives the option to link the monitor with a Display Port cable or a passive Display Port to DVI cable/adaptor.

Sound

- ALC888 HD Audio CODEC linked to the APU.
- PC speaker (buzzer).
- Digital interface (S/PDIF).
- Jack 1/8 plug for the analog interface.
- Onboard expansion connector for the HD Audio interface (7.1) and microphone input.
- Onboard audio amplifier providing at least 20W/channel for 2 channels (Left/Right). The amplified output is going to the edge connector.

USB

- 2x USB 3.0 ports available on the front panel. The maximum allowable current to be drained from the USB 3.0 ports is limited to 1.1A.
- 6x USB 2.0 ports available on the front panel. The maximum allowable current to be drained from the USB 2.0 ports is limited to 500mA.

Ethernet

- 1x 10/100/1000 MBPS Integrated Ethernet Controller (front panel connector RJ45).
- Fully compliant with IEEE 802.3, 802.3u and 802.3ab

Serial ATA

- 2x CFAST sockets supporting SATA 3.0 (data transfer up to 6GB/s)
- 1x On-board SATA connector using SATA 3.0 with optional +5V power on pin #7 for SATA DOM.

APU Memory (DDR4)

- Dual channel DDR4-2133MHz SODIMM Sockets (up to 2x32GB memory theoretical with 2GB of GPU shared memory).

BIOS

- AMI BIOS.
- A Coreboot BIOS will be developed later to enable security features required in jurisdiction such as Nevada state.
- The BIOS is programmed into an SPI flash installed on a Zero Insertion Force (ZIF) SOIC-8 socket. This is a requirement for some jurisdiction.

Serial Ports

- 4x RS232 on male DB9 connector (Printer, SAS, Touchscreen and Bill*).
- 3x RS232 on modular jack connector (Display**, GAT** and Spare232).
- 2x RS485 on modular jack connector (Network and Spare485***).
- 1x CCTALK*** on modular jack connector.
- 1x CCTALK on 4 pins connector.

* Can be configured as TTL or RS232 simulated

** Share the same modular jack

*** Share the same modular jack

DOORs Controller

- The system is responsible to monitor up to 8 different doors events.
- Real Time Clock chip.
- Lithium AA Battery, 3.6V, 1900mA.

Memories

- 4MBytes of Non-volatile SRAM with hardware lock. The approved technologies are Everspin MRAM and Cypress nvSRAM.
- 128MBytes of NOR flash (can be used to store logs or any game operation informations).

Security

- 16-pins machined socket to host a proprietary security device (SPHINX).
- 8-pins SIM card connector (push in/push out) to host a proprietary security card (SAM).

Miscellaneous

- 1-wire DS2502 Dallas key (hold Spider board unique serial number and IEEE OUI MAC address).
- External 1-wire interface on a 2-pins header.
- 1-wire temperature sensor for ambient.
- Fan control with PWM and sensing of the fan speed. Fan power is selectable between +5V and +12V.
- Pack of 8 dipswitch
- Power loss detection (AC-FAIL et POK).

Processor and Memory

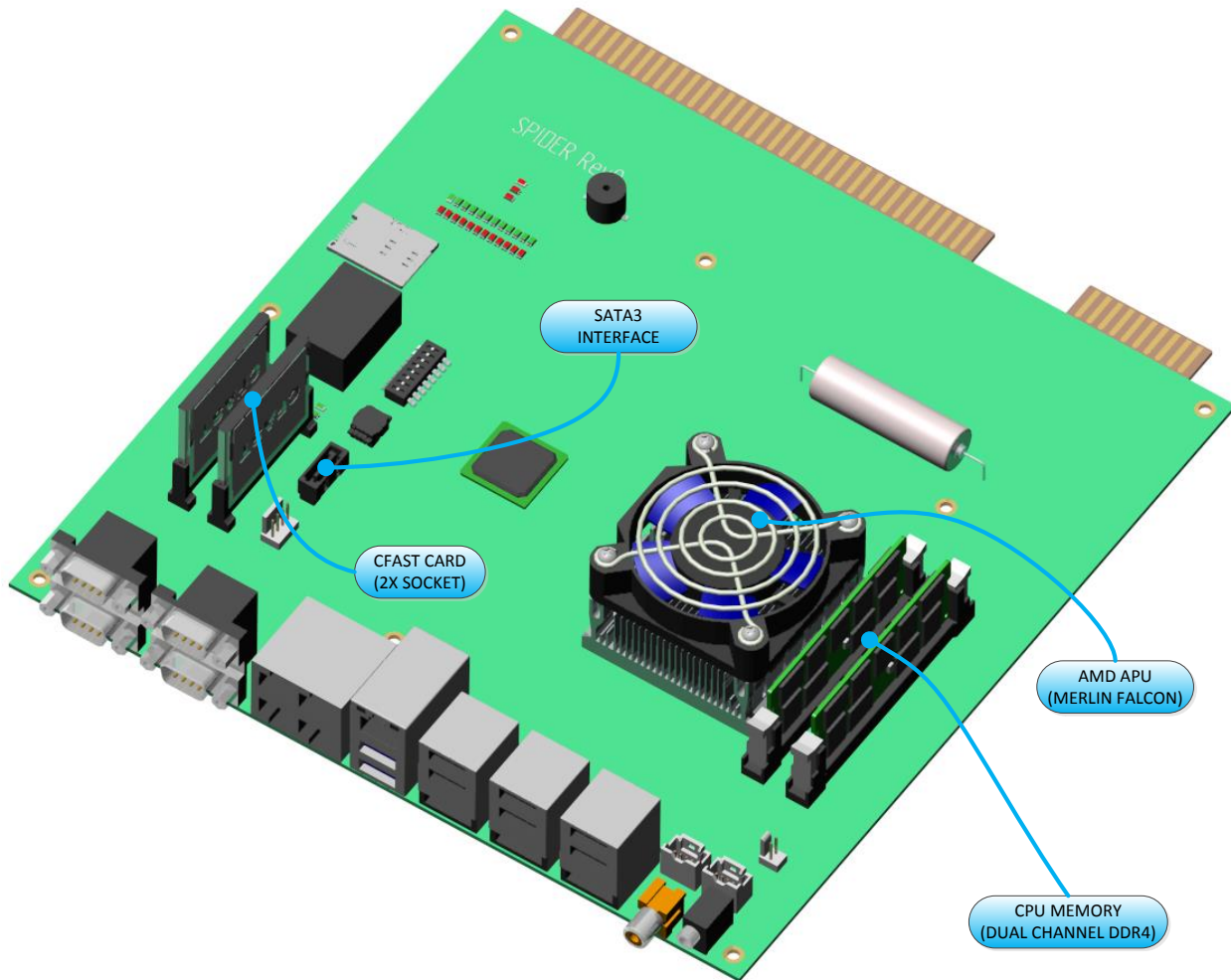

Serial ATA Connector

PIN	FUNCTION
1	GND
2	TX+
3	TX-
4	GND
5	RX-
6	RX+
7	GND*

*Optional +5VDC power according to assembly option
(contact vendor)

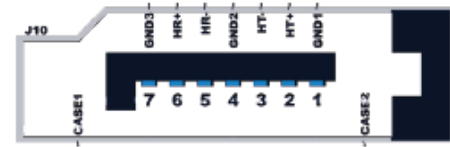

BIOS

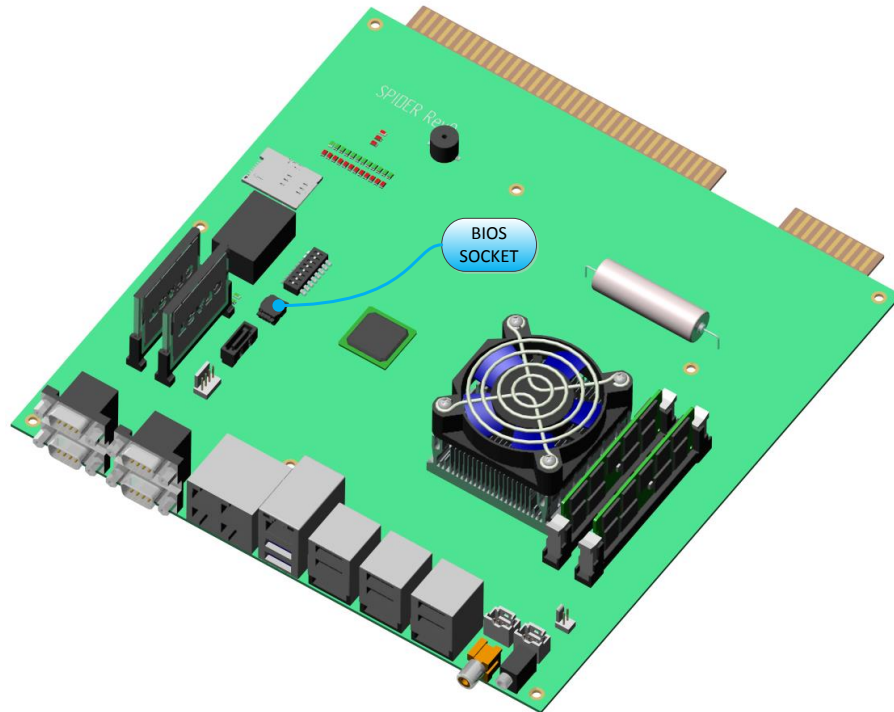

Feature an AMI BIOS or Coreboot BIOS. SPI flash (SOIC 8-pins) installed on a clamshell socket to allow easy removal and verification (signature) from required jurisdiction. Coreboot BIOS will meet Nevada state requirements.

Security

Door Tracking Controller:

Up to eight (8) door access monitoring inputs even when power is off and keeping track of the date and time (four available from edge connector and four from 24pins drawer connector).

SAM Card:

Software protection against piracy and software modification

SPHINX:

Software protection against piracy and software modification

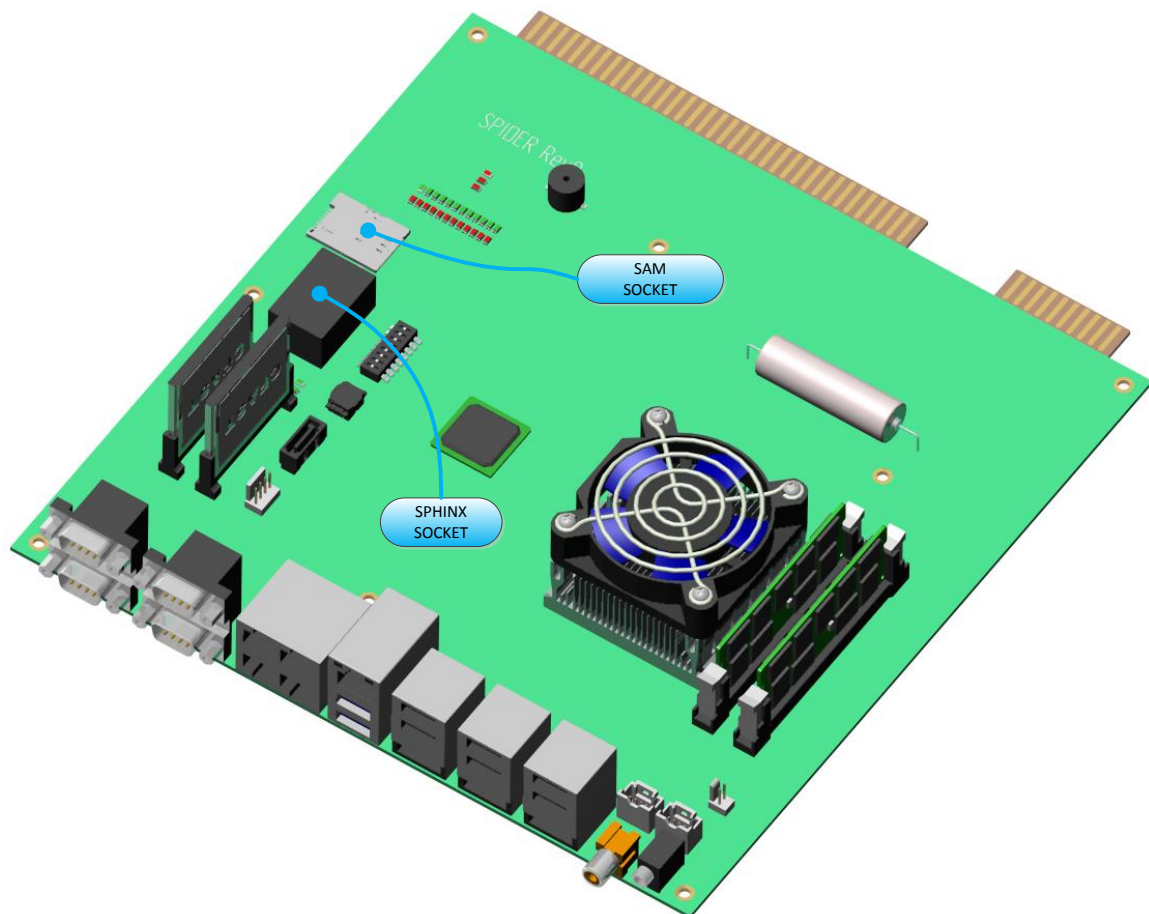

Sound and Video

Spider CPU comes with three native DP++ (Display Port) digital interfaces. DP++ interface can be used with an appropriate passive adaptor cable to get DVI or HDMI. An active adaptor is also available on the market to convert display port signal to VGA (HD15).

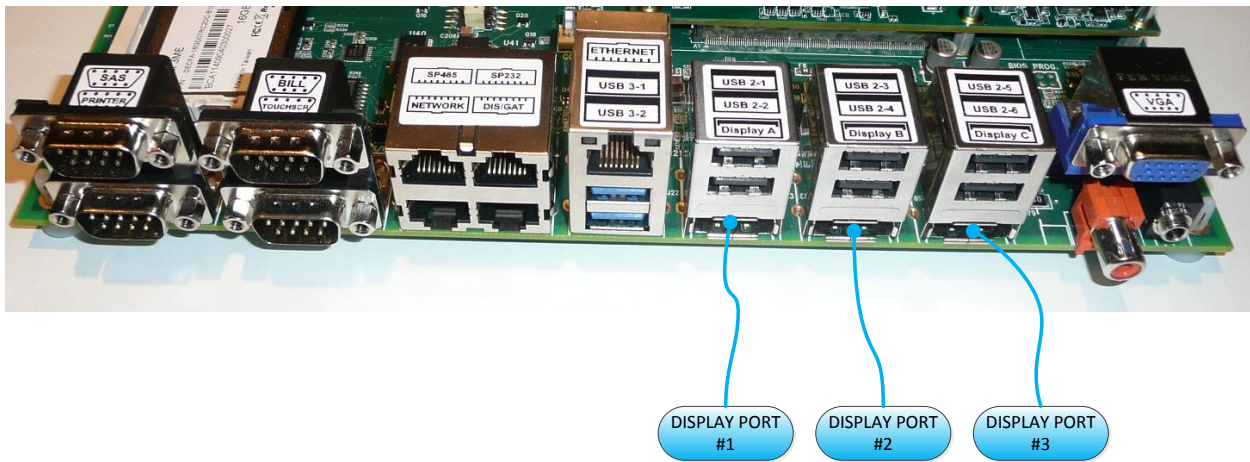

Sounds on the Spider CPU are generated from a Realtek ALC888S HD audio codec. A 1/8" jack and S/PDIF RCA are available in the front panel. It is also possible to have access to additional audio channel and microphone input from an expansion front panel connector. The Spider support up to 7.1 audio channels using S/PDIF digital interface.



An amplified stereo output (2x20W) is also available from the edge connector. See edge connector section for pinout.

Inputs and Outputs

Edge connector

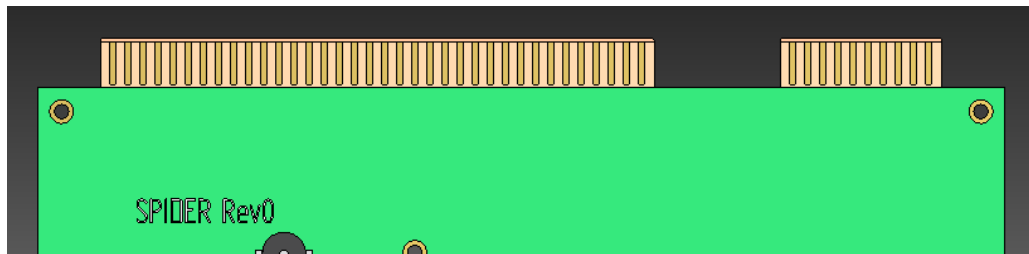

Available from edge connector:

- 31x digital inputs and 31x digital outputs (500mA, 50V max)
- 4x door monitoring inputs (4 additional available on drawer connector)
- Amplified stereo output for speakers
- 6x dedicated mechanical meters outputs
- Power output for mechanical meters
- AC monitoring circuit (early power failure detection)

20 PINS-EDGE (POWER)

Part Side	Pin	Solder Side
GND*	1	GND*
AC+	2	AC-
+5VDC*	3	+5VDC*
+5VDC*	4	+5VDC*
+12VDC*	5	+12VDC*
PWR_METERS**	6	PWR_METERS**
POK	7	HOPPER ENABLE
-	8	TICKET
GND*	9	GND*
GND*	10	GND*

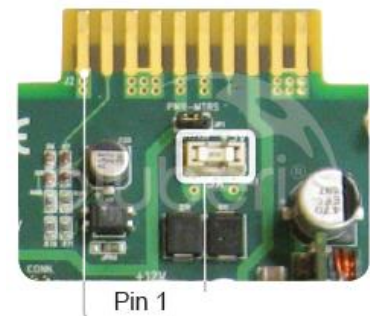

* These pins require an independent wire coming directly from the cabinet power supply or PDU. We recommend using 18Ga wire.

** Do not use to power peripherals other than meters.

72 PINS-EDGE (FULL PINOUT)

Part Side	Pin	Solder Side
SPARE METER #2	1	OUT1S
OUT2P	2	OUT2S
LEFT SPEAKER+	3	OUT3S
IN4P	4	LEFT SPEAKER-
SW HOPPER SENSE	5	RIGHT SPEAKER-
IN6P	6	IN6S
IN7P	7	IN7S
IN8P	8	IN8S
IN9P	9	IN9S
IN10P	10	IN10S
IN11P	11	IN11S
IN12P	12	RIGHT SPEAKER+
IN13P	13	SW CASH DOOR
IN14P	14	SW LOGIC DOOR
SW BILL DOOR	15	SW MAIN DOOR
IN16P	16	OUT16S
+5VDC (OUT)*	17	HOPPER DIVERTER
SW SLOT #1	18	SW SLOT #3
SW SLOT #2	19	COIN ENABLE
KEYSW CLEAR ERROR	20	KEYSW OPERATOR MENU
IN21P	21	IN21S
SW HOPPER FULL	22	SW HOPPER COIN
CASH IN METER	23	GND
CASH PLAYED METER	24	OUT24S
SPARE METER #1	25	IN25S
CASH WON METER	26	IN26S
IN27P	27	OUT27S
CASH PAID METER	28	OUT28S
OUT29P	29	OUT29S
OUT30P	30	OUT30S
OUT31P	31	OUT31S
OUT32P	32	OUT32S
OUT33P	33	CANDLE 3H/2L
CANDLE 3M/2H	34	CANDLE 3L
OUT35P	35	IN35S
GND	36	GND

* Do not use to power peripherals.

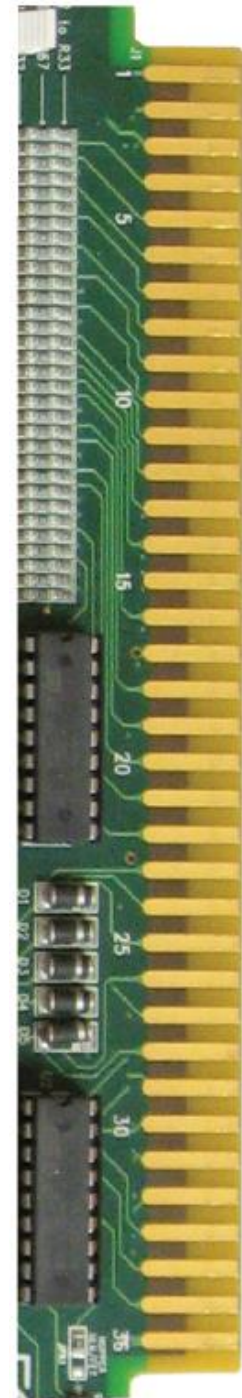

Expansion Drawer Connector



24-PINS DRAWER CONNECTOR

PIN	FUNCTION
1	+3.3VDC
2	+3.3VDC
3	GND
4	+5VDC
5	GND
6	+5VDC
7	GND
8	POK PSU
9	+5VSB PSU
10	+12V
11	SW DOOR5
12	DKEY+
13	+3.3VDC
14	-12VDC
15	GND
16	SW DOOR6
17	SW DOOR7
18	GND (LOGIC)
19	GND
20	SW DOOR8
21	+5VDC
22	+5VDC
23	SW LOGIC DOOR (LOOP)
24	DKEY-

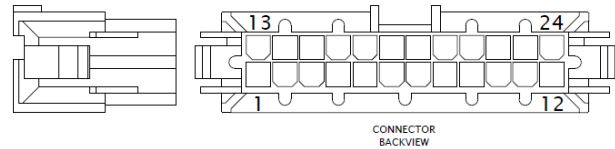

Front Panel Connections

Serial Ports (RS232 & RS485)

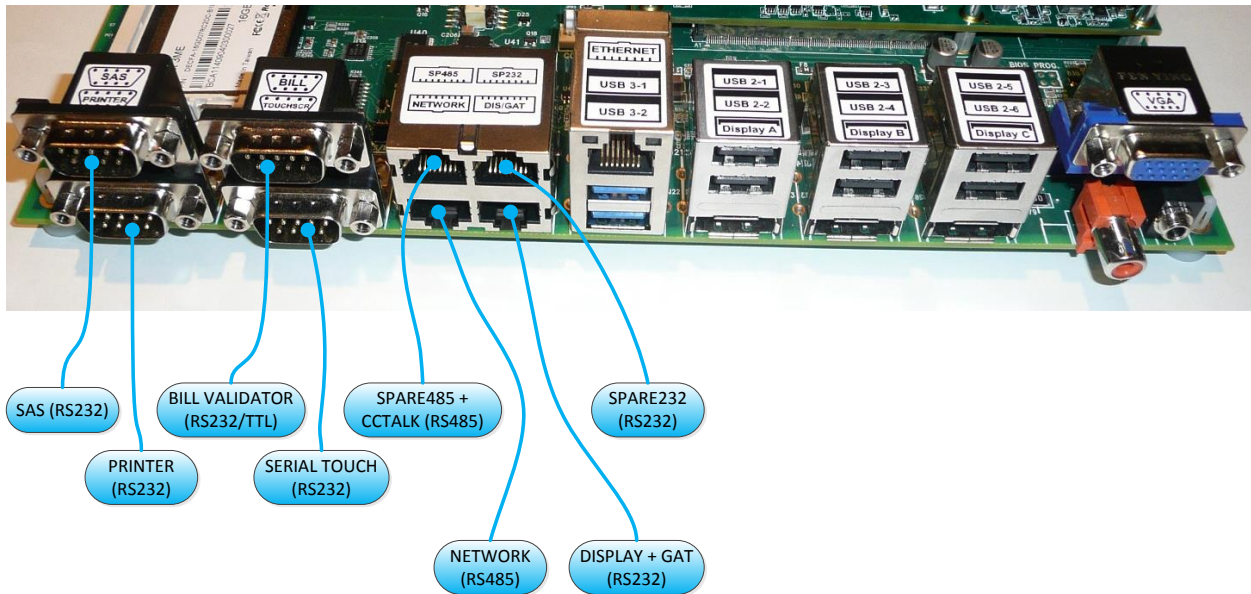

SAS DB-9 Connector

PIN	FUNCTION
1	NC
2	RXD
3	TXD
4	DTR
5	GND
6	DSR*
7	RTS
8	CTS*
9	NC

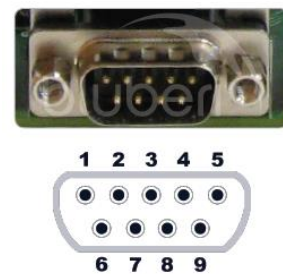

* According to JP1 (handshake signal jumper)

Printer DB-9 Connector

PIN	FUNCTION
1	NC
2	RXD
3	TXD
4	DTR
5	GND
6	DSR*
7	RTS
8	CTS*
9	NC

* According to JP2 (handshake signal jumper)

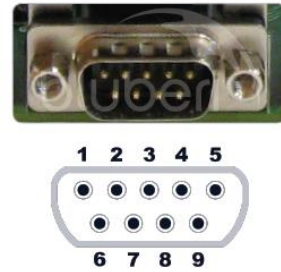

Bill Validator DB-9 Connector

PIN	FUNCTION
1	NC
2	RXD
3	TXD
4	BILL ENABLE
5	GND
6	NC
7	RTS
8	CTS
9	NC

Can be configured as TTL or RS232 simulated

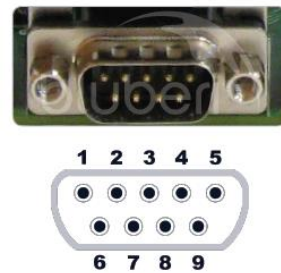

Serial Touch DB-9 Connector

PIN	FUNCTION
1	NC
2	RXD
3	TXD
4	DTR
5	GND
6	DSR*
7	RTS
8	CTS*
9	NC

* According to JP4 (handshake signal jumper)

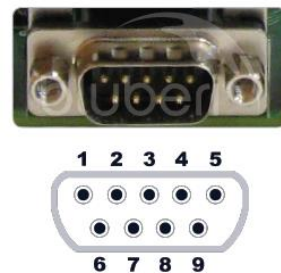

Spare485 + CCTALK RJ-45 Connector (RS485 + CCTALK)

PIN	FUNCTION
1	CCTALK RJ45
2	DOUT-
3	DOUT+
4	GND
5	GND
6	DIN+
7	DIN-
8	NC



Network RJ-45 Connector (RS485)

PIN	FUNCTION
1	DOUT+
2	DOUT-
3	DIN+
4	GND
5	GND
6	DIN-
7	NC
8	NC



Spare232 RJ-45 Connector (RS232)

PIN	FUNCTION
1	NC
2	RTS
3	TXD
4	GND
5	GND
6	RXD
7	CTS
8	NC



Display + GAT RJ-45 Connector (RS232)

PIN	FUNCTION
1	RXD GAT
2	TXD GAT
3	TXD DISP.
4	NC
5	RXD DISP.
6	NC
7	GND
8	GND



Ethernet and USB

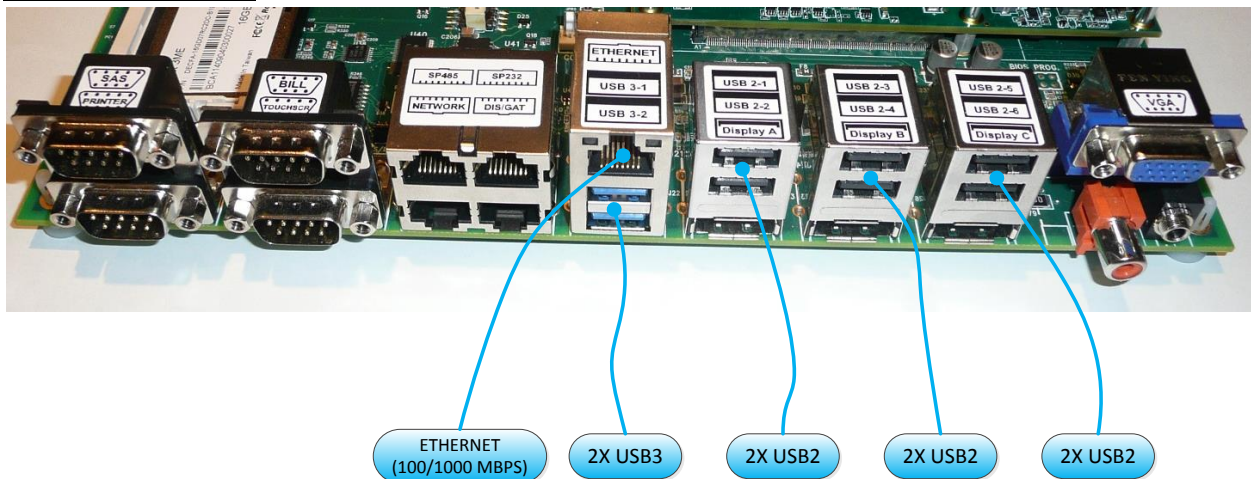

Ethernet RJ-45 Connector (10/100/1000 MBPS)

PIN	FUNCTION
1	TXXR A+
2	TXXR A-
3	TXXR B+
4	TXXR C+
5	TXXR C-
6	TXXR B-
7	TXXR D+
8	TXXR D-



USB2 Connector

PIN	FUNCTION
1	+5VDC*
2	DAT-
3	DAT+
4	GND

*+5VDC current limited to 500mA for USB2



USB3 Connector

PIN	FUNCTION
1	+5VDC*
2	DAT-
3	DAT+
4	GND
5	STDA_SSRX-
6	STDA_SSRX+
7	GND DRAIN
8	STDA_SSTX-
9	STDA_SSTX+

*+5VDC power limited to 1.1A for USB3



CCTALK

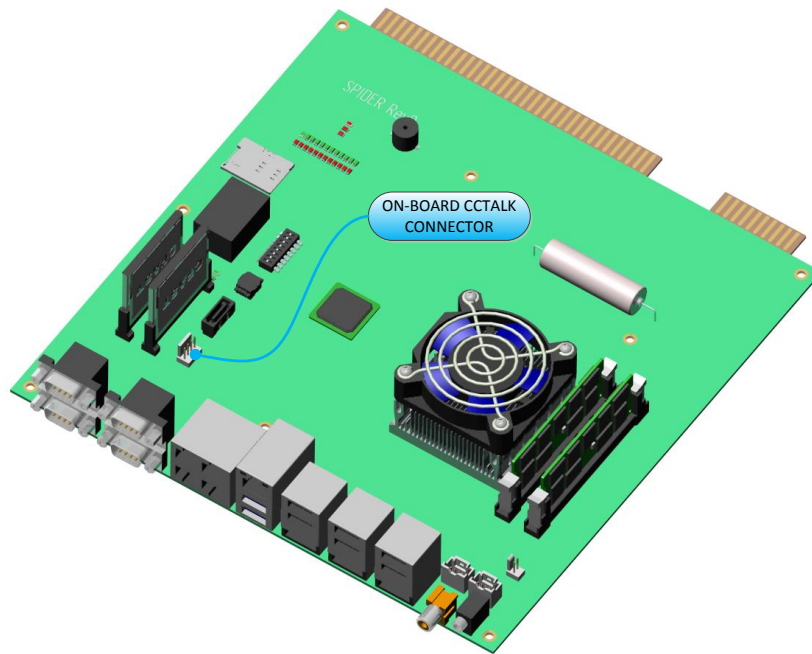

CCTALK Connector

PIN	FUNCTION
1	CCTALK DATA
2	GND
3	NC
4	+12VDC



Miscellaneous

DIP Switch

An 8 position DIP switch is available on the Spider CPU for software configuration.

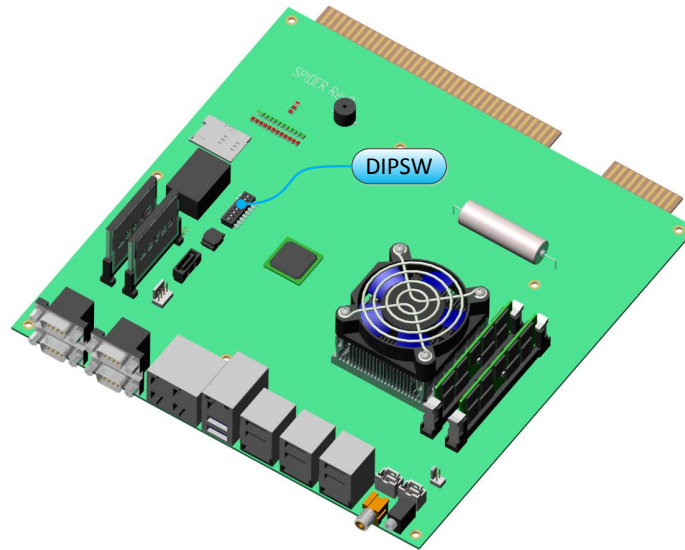

DIPSW#	POS	FUNCTION
DIP SWITCH #1	OFF	NORMAL START-UP (LOAD CFAST GAME)
	ON	REMAIN IN APPLICATION LOADER APP.
DIP SWITCH #2	OFF	IP ADDRESS REQUESTED FROM DHCP
	ON	DISABLE ETHERNET
DIP SWITCH #3	OFF	RESERVED
	ON	RESERVED
DIP SWITCH #4	OFF	DISABLE SERIAL TOUCHSCREEN SUPPORT
	ON	ENABLE SERIAL TOUCHSCREEN SUPPORT
DIP SWITCH #5	OFF	RESERVED
	ON	RESERVED
DIP SWITCH #6	OFF	NOT USED
	ON	NOT USED
DIP SWITCH #7	OFF	NOT USED
	ON	NOT USED
DIP SWITCH #8	OFF	NORMAL RESET
	ON	HARD RESET*

* Only available on request for specific games.

On-board and external DKEY

An external identification key connector is available providing the cabinet's unique serial number.

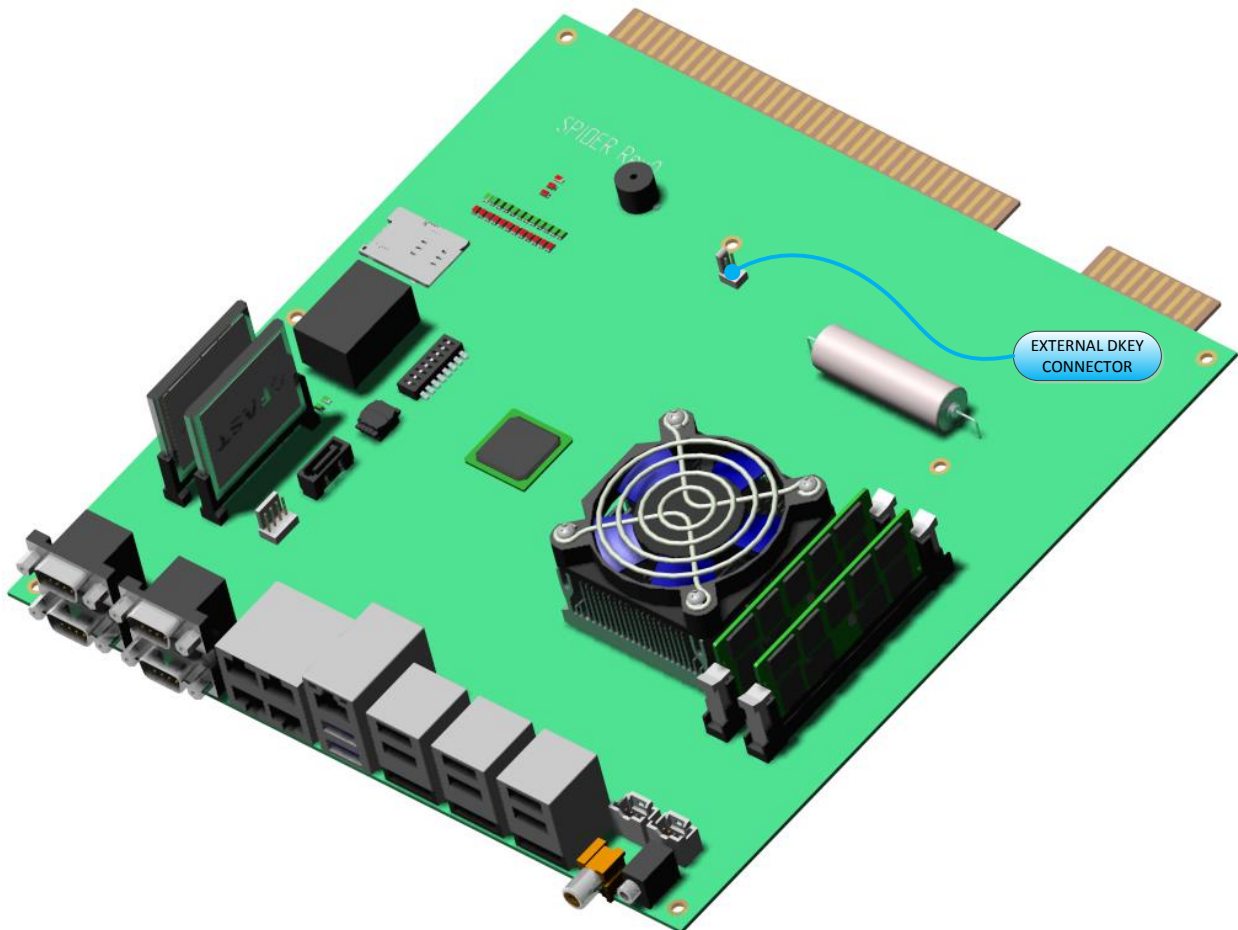

An on-board identification key is available providing the Spider's CPU board unique serial number.

Contact Us

If you have any question, comment or feedback, please use the contact details provided below.

Bluberi Gaming Canada Inc.

2120, rue Letendre

Drummondville (Québec) J2C 7E9

CANADA



819.475.5155

1.800.720.5155 (U.S. toll-free number)



819.475.5156



www.bluberi.com

Technical Support



1.866.THE.GAME (1.866.843.4263)



support.bluberi.com



support@bluberi.com

© 2015 Bluberi Gaming Canada Inc.

All rights reserved. No part of this document may be reproduced, in any form or by any means, without prior written authorization from Bluberi Gaming Canada Inc.

The information contained in this document represents the current view of Bluberi on the issues discussed as of the date of publication. Because Bluberi must respond to changing market conditions, the comprised information should not be interpreted as a commitment on the part of Bluberi, and Bluberi does not guarantee the accuracy of any presented information.

This document is for informational purposes only. BLUBERI MAKES NO WARRANTIES, EXPRESSED OR IMPLIED, IN THIS DOCUMENT.

Other product and company names mentioned herein may be the trademarks of their respective owners.