

SOFTWARE INSTALLATION AND SETUP

Bluberi Novus B49 Class 3 EGMs

Version

1.0.1

Department

TEC-EL-04229

Creation date

2024-11-19

Audience

Field Service Technicians
Slot technicians



Version History

Version	Department	Initials	Date	Comments
1.0.1	Field Service	BC	11/19/2024	Manual Revamp

Contents

Version History	2
1. Introduction.....	4
2. Initial Preparation.....	4
3. RAM Clear Process	5
4. Game CF Card and SAM Card Installation	8
5. Configuration Menu Settings.....	11
6. Finalizing the Setup	22
7. Troubleshooting.....	23
Contact Us.....	24

1. Introduction

This manual provides detailed instructions for setting up and configuring class 3 software for Bluberi Novus B49 EGMs.

2. Initial Preparation

1. Power down the EGM.

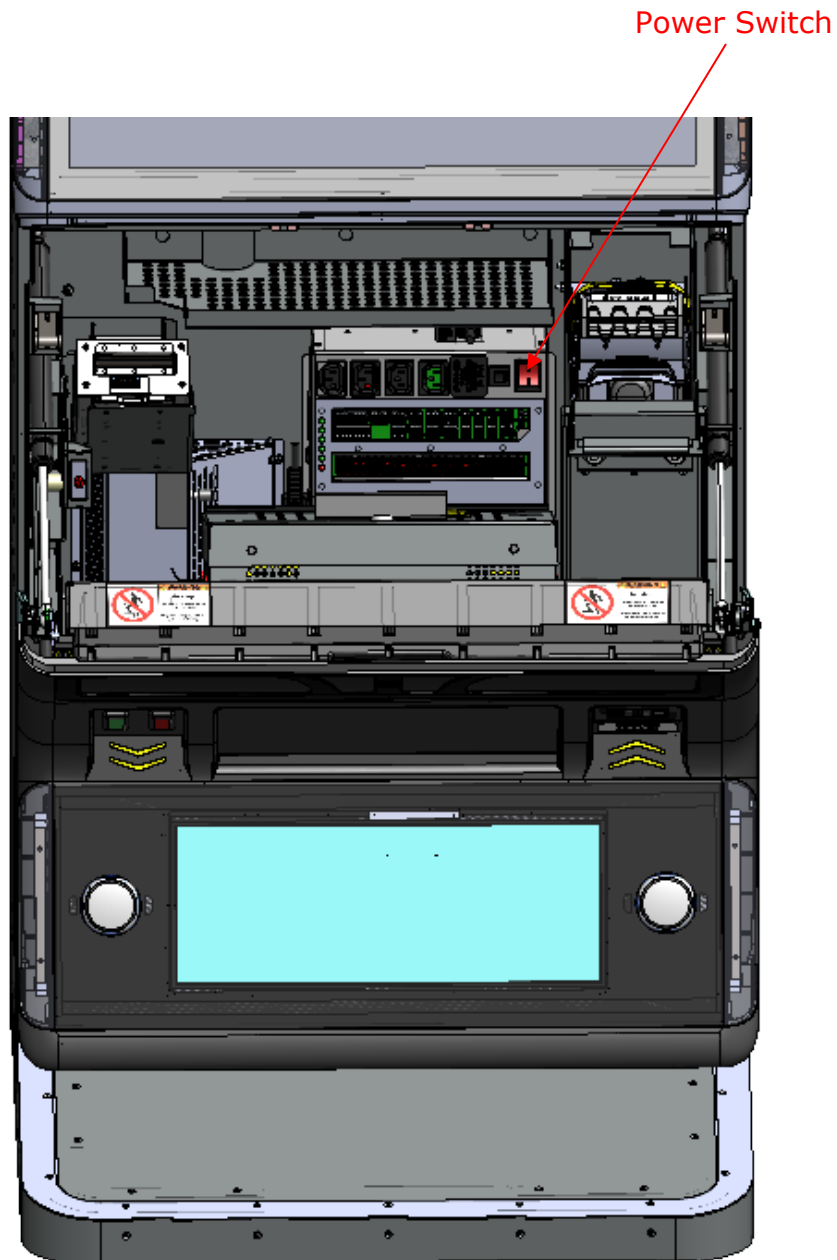

Power Switch

2. Remove any existing software.

Game CF Card

SAM Card

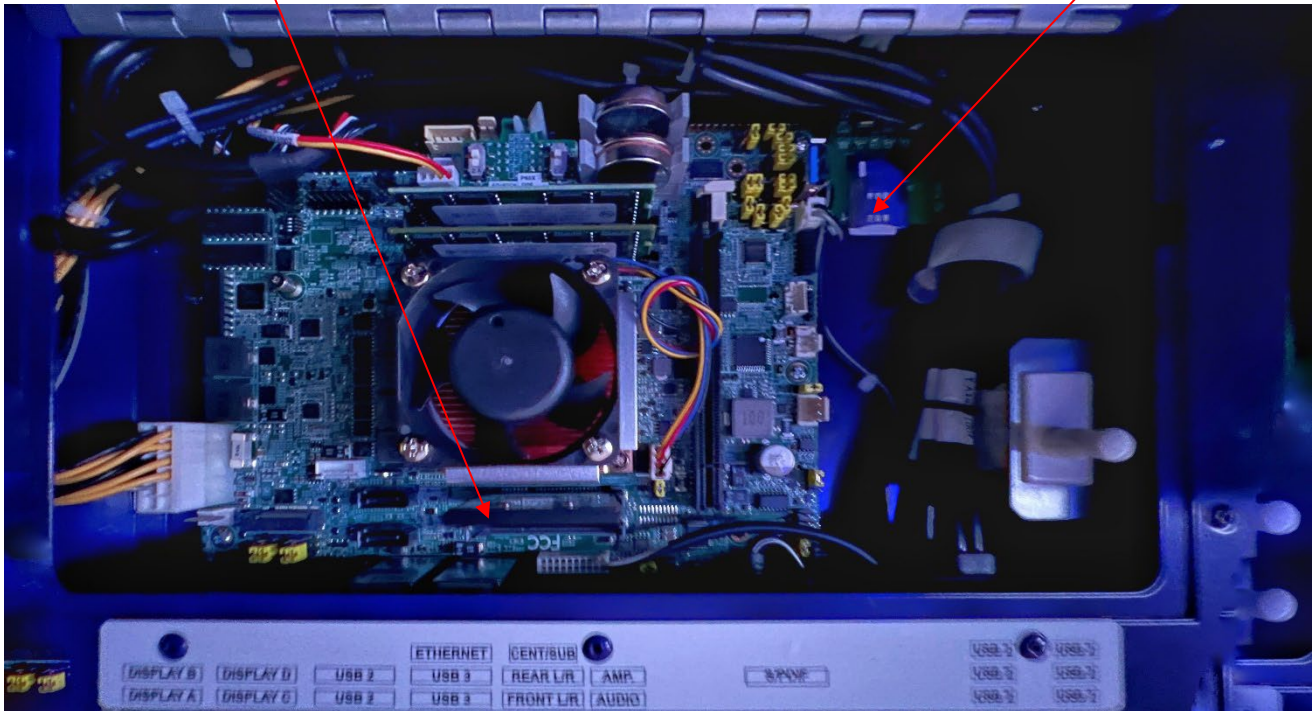

3. RAM Clear Process

1. Insert the RAM clear card into any CF slot.
2. Power on the EGM.
3. Select **Novus B49 2.0 with topper** (select **without topper** if you aren't using one). Use the service button to move selection down and use play or cashout buttons to select.

```
Versions: app=0.3 Imocore driver=3.2.3.210 Board-dev=0x180 rev=20 board=DPX-S450 rev=0
Press COLLECT, DEAL or turn ATTENDANT KEY to select a configuration
Press any other button or turn OPERATOR MENU KEY to change the selection

  1 - Bluberi Beacon, Topper
  2 - Bluberi Novus B49 2.0, Topper
  3 - Bluberi Novus B49 2.0
  4 - Phoenix Stepper
  5 - Bluberi Novus B49 1.0
  6 - Bluberi Novus B49 1.0, Topper
  7 - Bluberi Novus B49, Topper, Doors Normally Open
  8 - Bluberi Novus B27
  9 - Bluberi Novus B27 1.5
 10 - Bluberi Novus B27 1.5, Matrox splitter, POD
 11 - Bluberi Novus B27 1.5, Matrox splitter, Topper
 12 - Bluberi Novus B27, Matrox splitter, POD
 13 - Bluberi Novus B27, Matrox splitter, Topper
 14 - Big Mech
 15 - Bluberi 2451/Nitro

Revision: D
Comment: 1 monitor 3840x2160 + ButtonDeck 1920x1080 + 1 topper 1920x1080 + 2 USB touchscreens
```

4. Calibrate the **main monitor** and **touchdeck** by touching each screen when prompted with touch this screen.

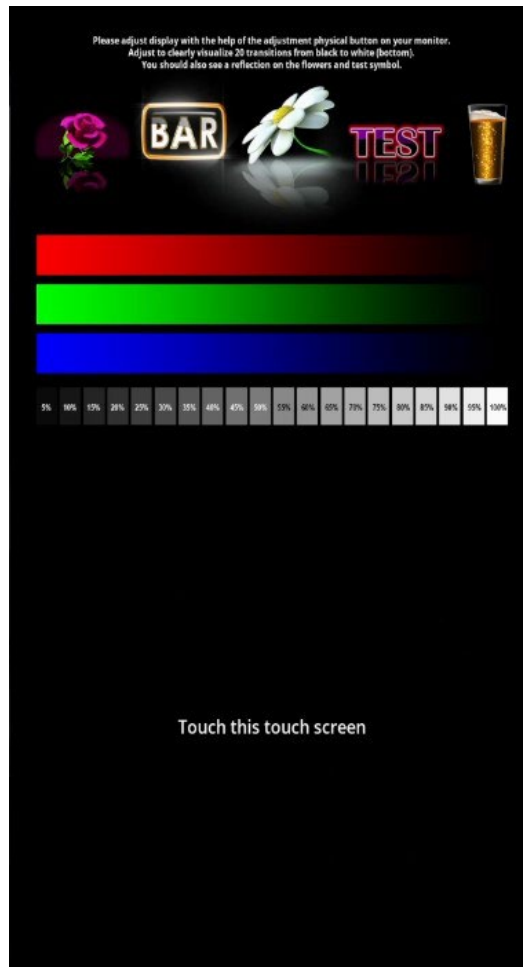

5. Once the machine fully loads, select **RAM Clear** from the menu.



6. When asked to proceed, select **Yes**.

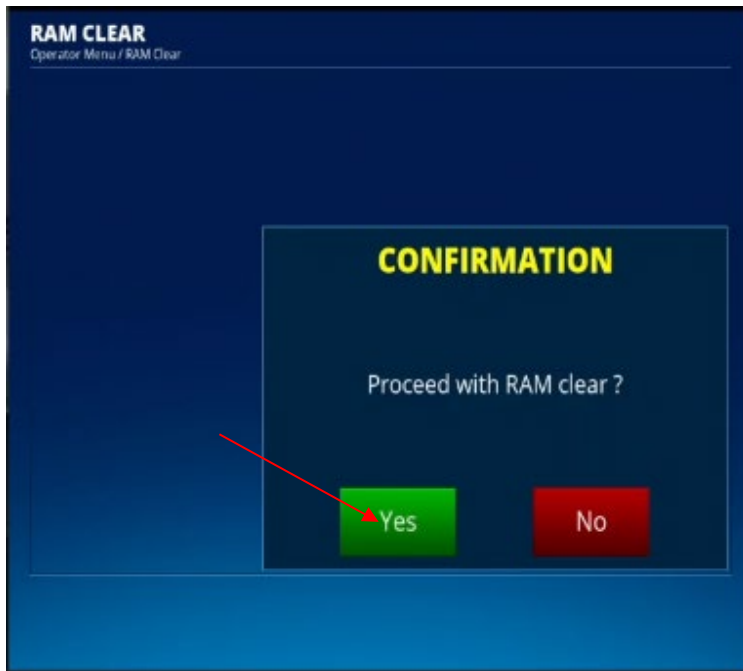

7. Once the process completes and 'Done' appears on the screen, power down the machine.

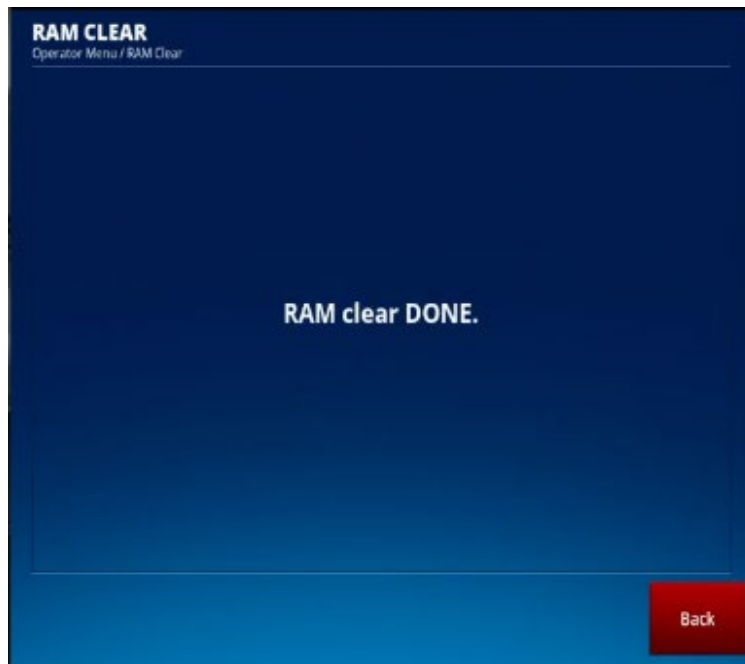

8. Remove the RAM clear CF card.

4. Game CF Card and SAM Card Installation

1. With the machine powered down, insert the **Game CF card** and **SAM card**.
2. Power on the machine.

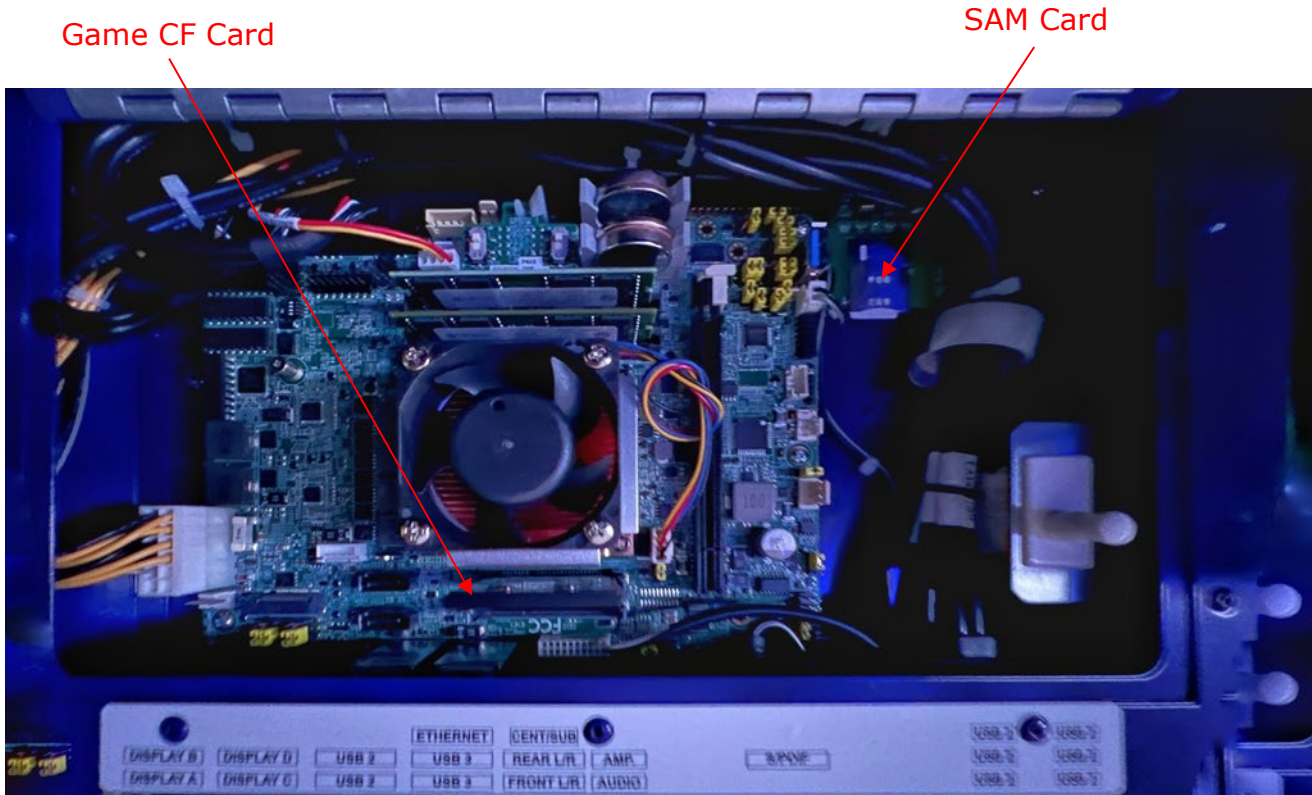

3. During cabinet selection, select **Novus B49 2.0 with topper** (or **without topper** if you aren't using one).

```
Versions: app=0.3 Imcore driver=3.2.3.210 Board-dev=0x180 rev=20 board=DPX-S450 rev=0
Press COLLECT, DEAL or turn ATTENDANT KEY to select a configuration
Press any other button or turn OPERATOR MENU KEY to change the selection

  1 - Bluberi Beacon, Topper
  * 2 - Bluberi Novus B49 2.0, Topper
    3 - Bluberi Novus B49 2.0

Revision: D
Comment: 1 monitor 3840x2160 + ButtonDeck 1920x1080 + 1 topper 1920x1080 + 2 USB touchscreens
```

- When prompted, calibrate the **main monitor** and **touchdeck** touch screen by touching each screen when asked to touch this screen.

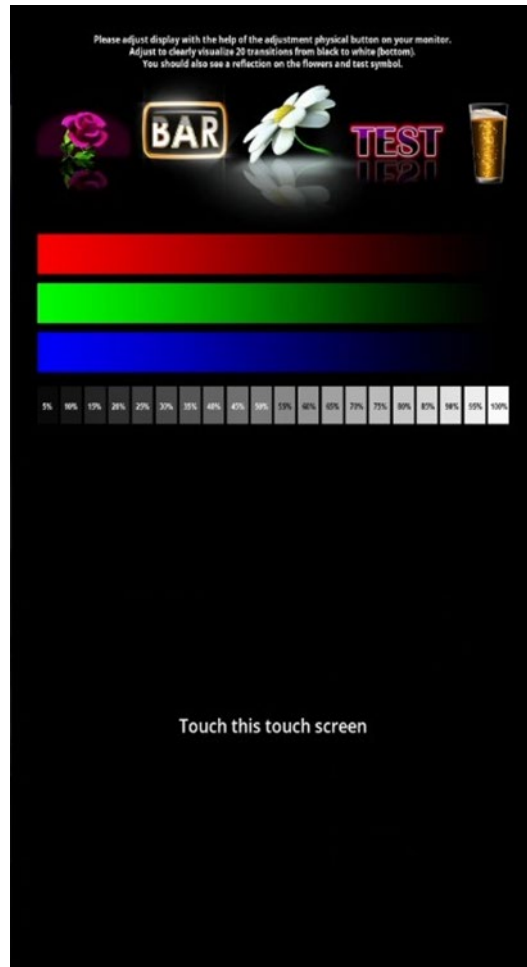

- When the machine loads, enter the operator menu by turning the left menu key.

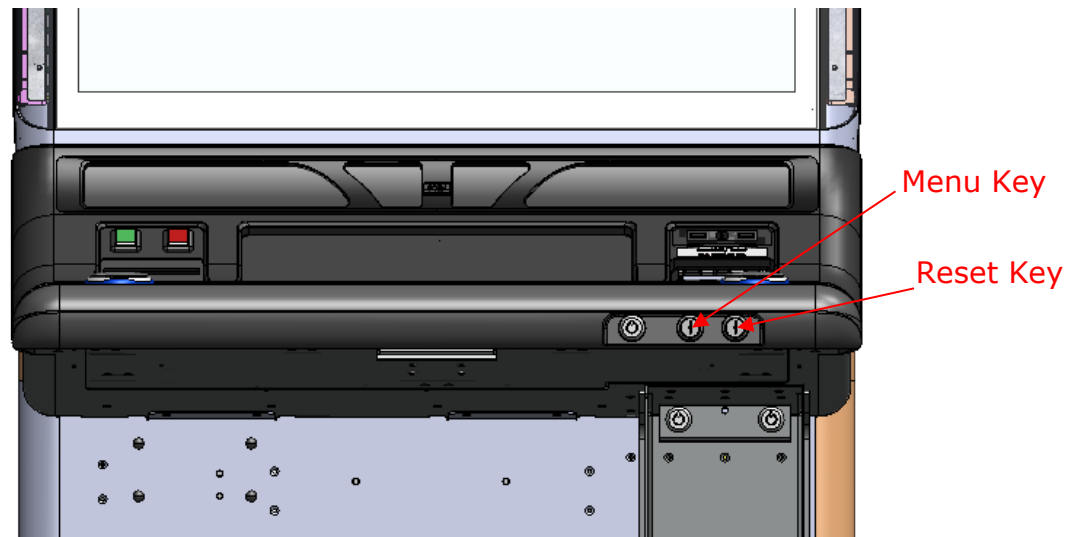

6. Keep the key turned and select **Operator Menu** at the bottom of the screen.



7. With the main door open and the left menu key still turned, select **Configuration**.



8. Start at the top of the menu and work your way down.



5. Configuration Menu Settings

1. General Settings:

- Select **General Settings**.

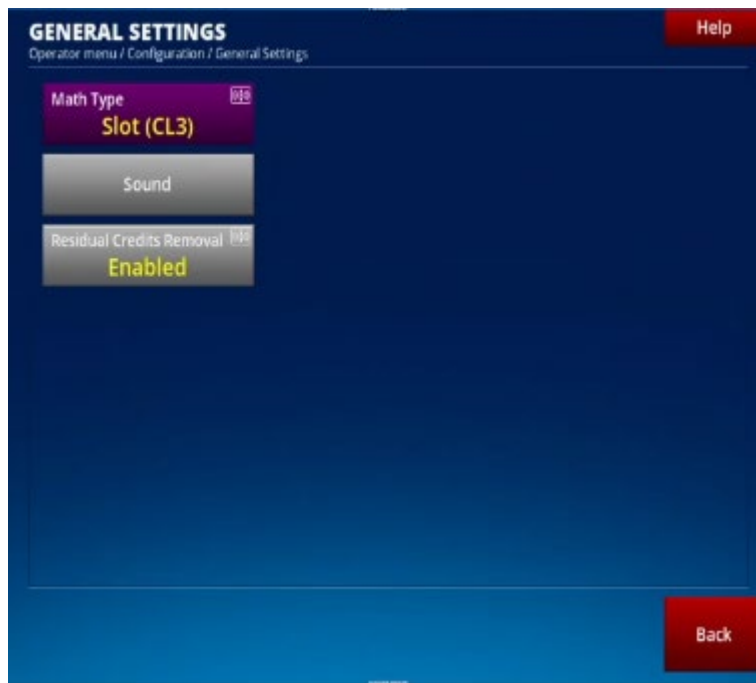

- It is recommended to leave all settings at their default values unless specific adjustments are required (e.g., master volume or language).

2. Game Theme Menu:

- Select **Game Theme**.



Enable the game, set up denominations, and set average payout percentage:

- Select game.
- Select **Enable**.

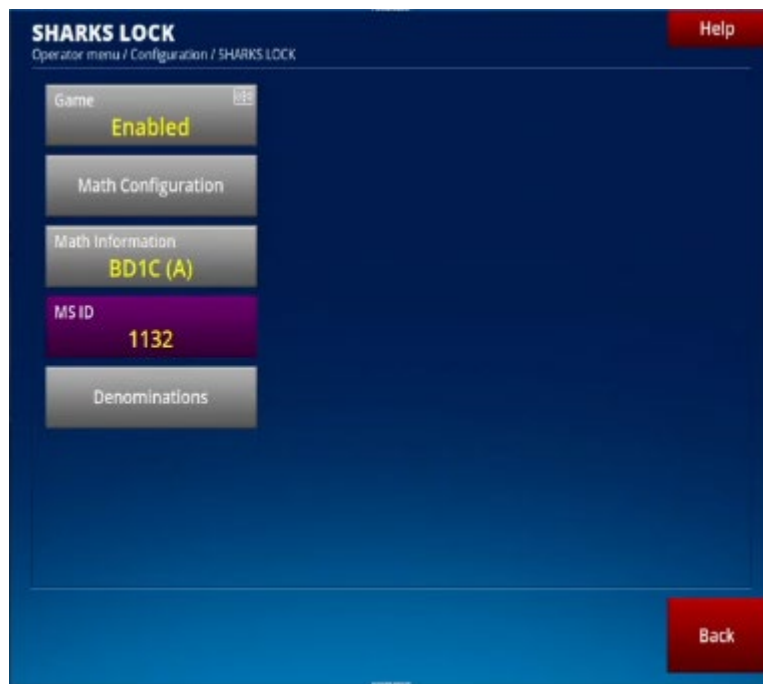

➤ Select **Denominations**.

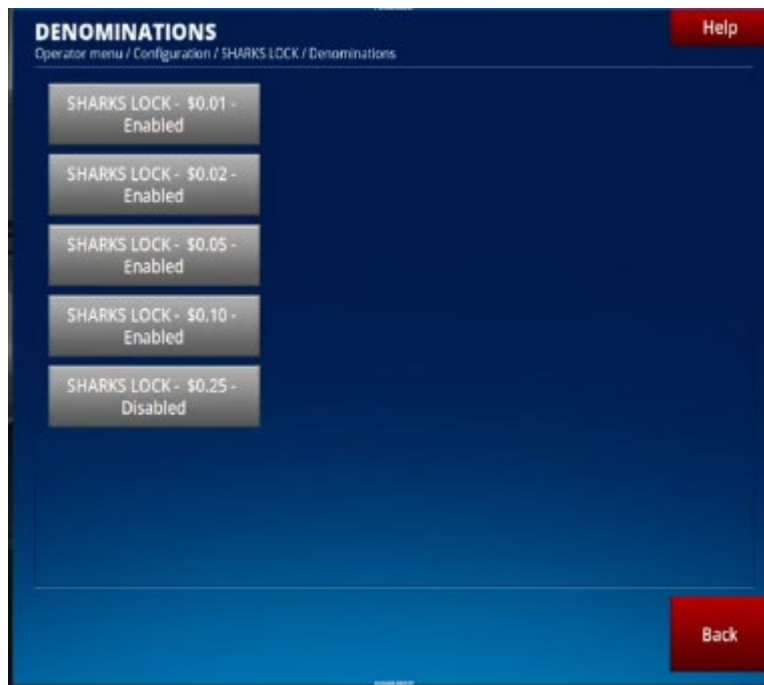

➤ Select a denomination:

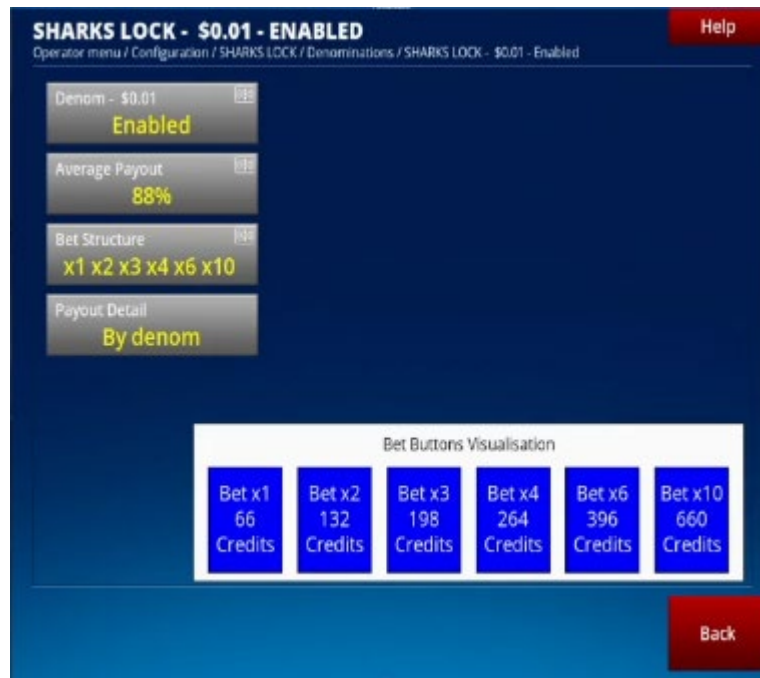

- To disable a denomination, select the **Denom** and then select **Disable**.

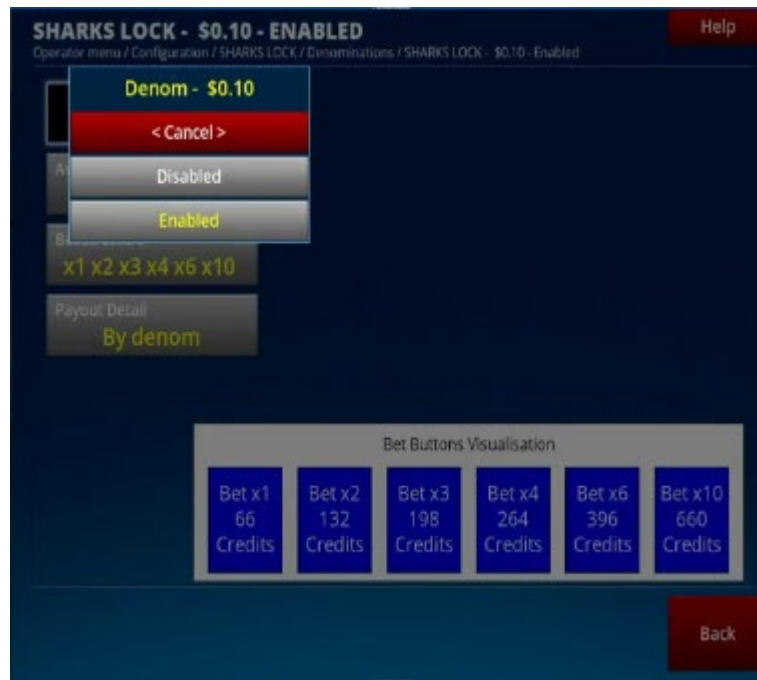

- To enable a disabled denomination, select the **Denom** and then select **Enable**.
- To change your payout percentage, select **Average Payout** and then select the desired percentage.

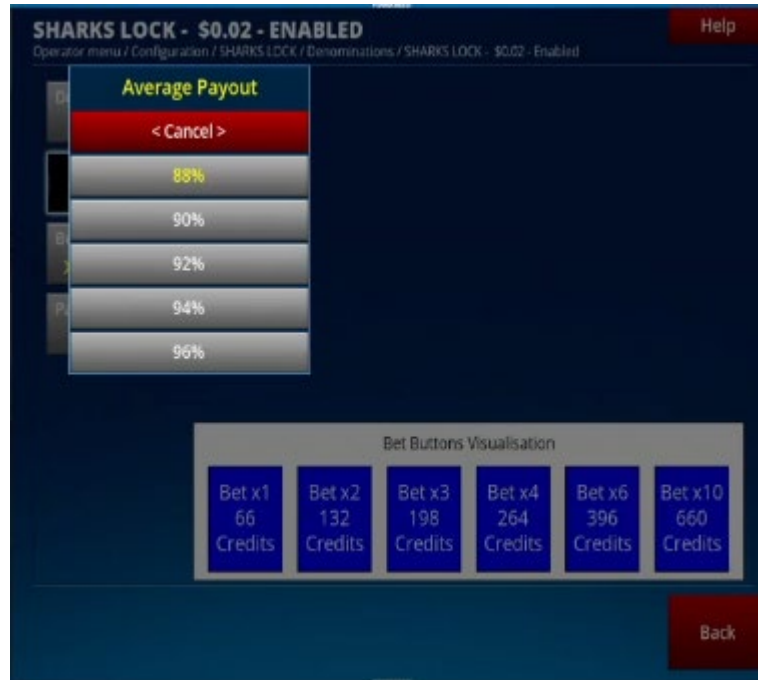

- Repeat these steps for each denomination.

3. Peripherals:

- Back out of the game theme menu and select **Peripherals**.

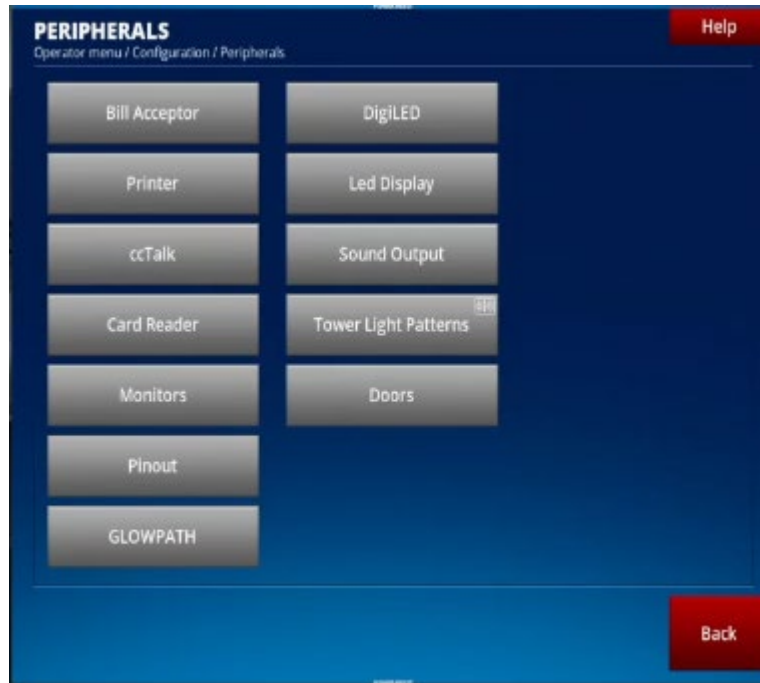

- Select the **Bill Acceptor** menu:
- Select Bill Type, select the installed bill acceptor type and back out, leaving all other settings at default.

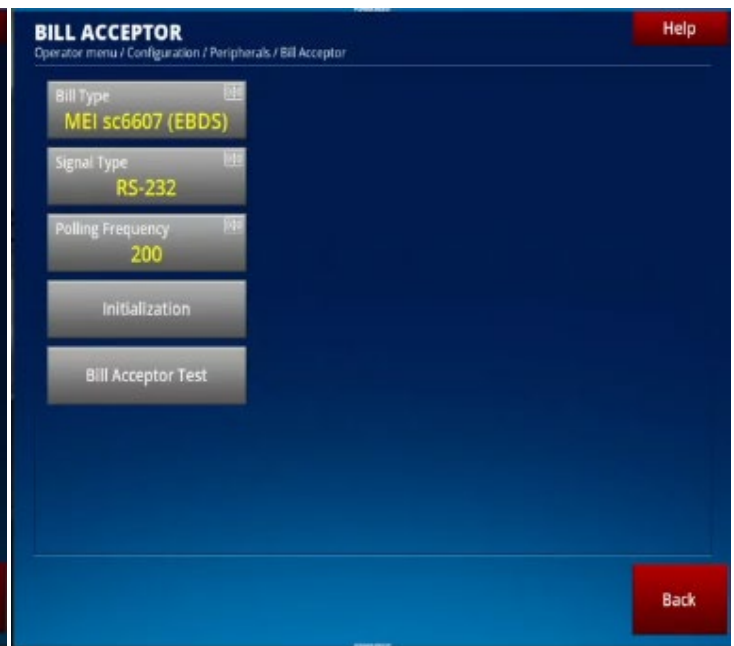

- Configure the **Printer**:
- Select Printer, select the installed printer type and back out, leaving all other settings at default.



4. Network Settings:

- Back out of the peripherals menu and select the **Network Menu**.

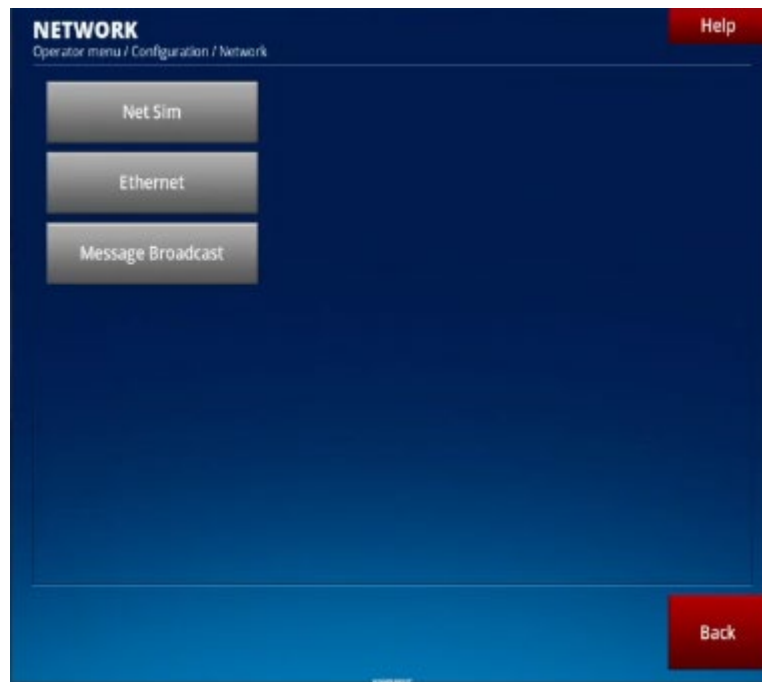

- Select **NetSim Menu**:



- Select **Machine Number** and enter the machine position on the bank.
- Select **Terminal Number** and enter the machine asset number.
- For Class 3, disregard settings related to Net Sim, Ethernet Port, and IP Address, as these are applicable to Class 2 configurations only.
- Back out of the NetSim menu and select **Ethernet Menu**:



- If not connected to a progressive controller setup, select **Mode** and disable **DHCP**.

5. System Menu:

- Back out of the network menu and select **System Menu**.
- Select **EGM Serial Number** and enter the EGM serial number (format: BB-XXXX). The terminal number (asset number) should already be populated.
- Ensure **Hard Meter Unit** is set to \$0.00.



- Select **Jackpot and Credit Limits** menu:

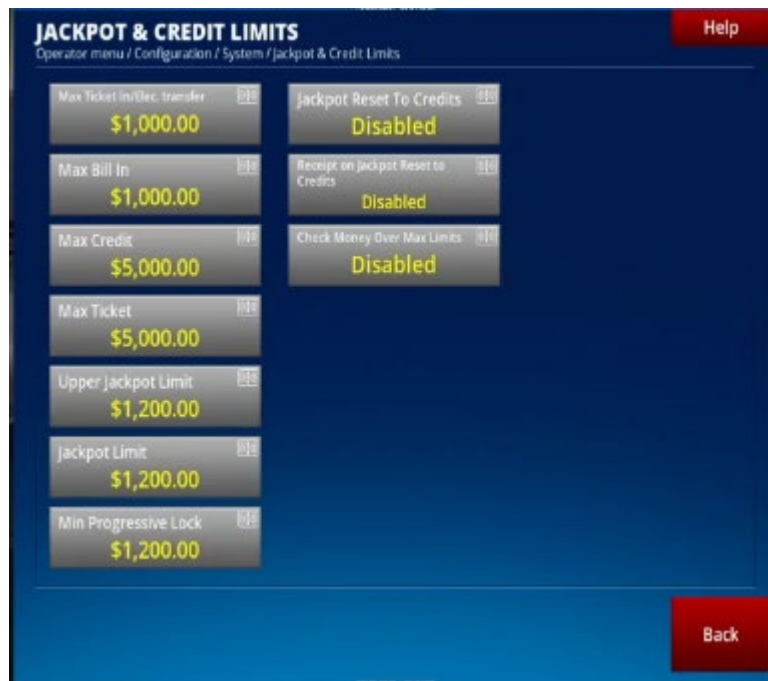

- Select **Min Progressive Lock** and enter the desired amount.
- Select **Jackpot Limit** and enter the desired amount.
- Select **Upper Jackpot Limit** and enter the desired amount.
- Select **Max Ticket In** and enter the desired amount.
- Select **Max Credit** and enter the desired amount.
- Select **Max Ticket In/Electronic Transfer** at the top and enter the desired amount.
- Select **Max Bill In** and enter the desired amount.
- If using **Jackpot Resets to Credits**, enable it here (usually disabled along with **Check Money Over Max Limits**).

6. Collect Mode:

- Back out of the Jackpot and Credit Limits menu and the System Menu.
- Select **Collect Mode**:

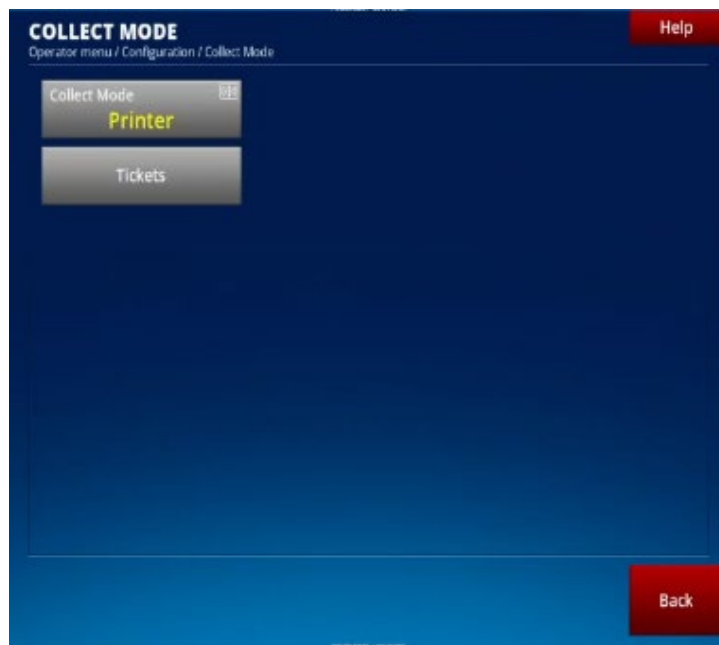

- If using a printer, ensure the printer is selected.
- If using electronic transfer only without a TITO system, select Electronic Transfer.

7. Management System:

- Back out of Collect Mode and select Management System.

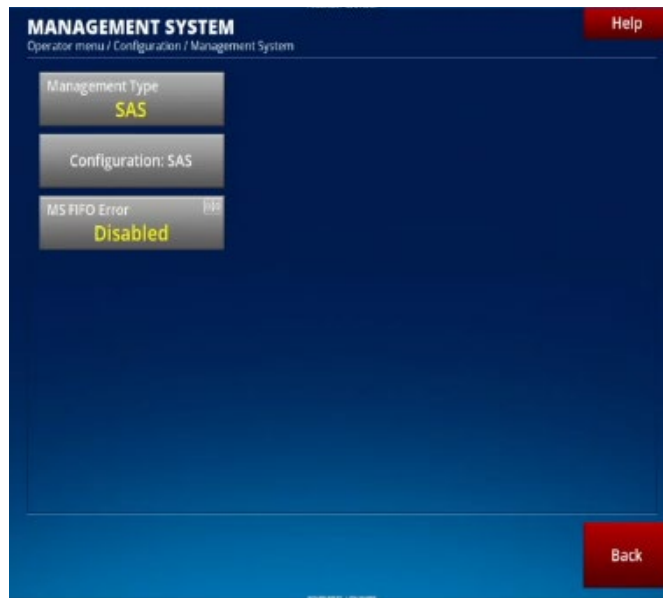

- Ensure **SAS** is selected under **Management Type**.
- Select **Configuration SAS** menu:

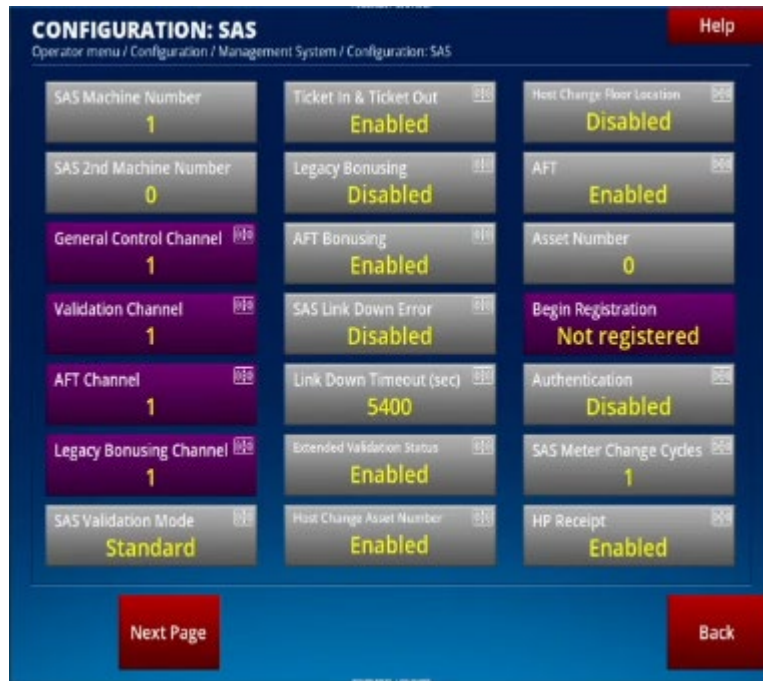

- Select **SAS Machine Number** and enter **1** to turn on **SAS port 1**.
- If using a SMIB device in SAS 2, select SAS 2nd Machine Number and enter the machine number on the bank. Change General Control Channel to 2 (used in lottery jurisdiction properties).
- Configure options based on your player tracking setup (selected by the property).
- Select Next Page for additional settings.
- If using a SMIB, ensure Pay Table Metering is enabled for remote access to paytables.



6. Finalizing the Setup

1. Review all settings to ensure they are configured correctly.
2. Exit out of all the menus.
3. Load the game.
4. The setup is now complete.



7. Troubleshooting

This section provides solutions to common issues encountered during the setup process.

RAM Clear Issues:

- Ensure the RAM clear card is properly inserted and reboot.

Monitor Calibration Problems:

- Restart the calibration process by restarting the RAM clear process and ensure screens are clean and responsive.

Configuration Menu Access Issues:

- Check the menu key is tuned and ensure the main door is open.

Diagnostic Menu:

- From the system information page, select diagnostic menu. Here you can test each device to make sure it's functioning properly.

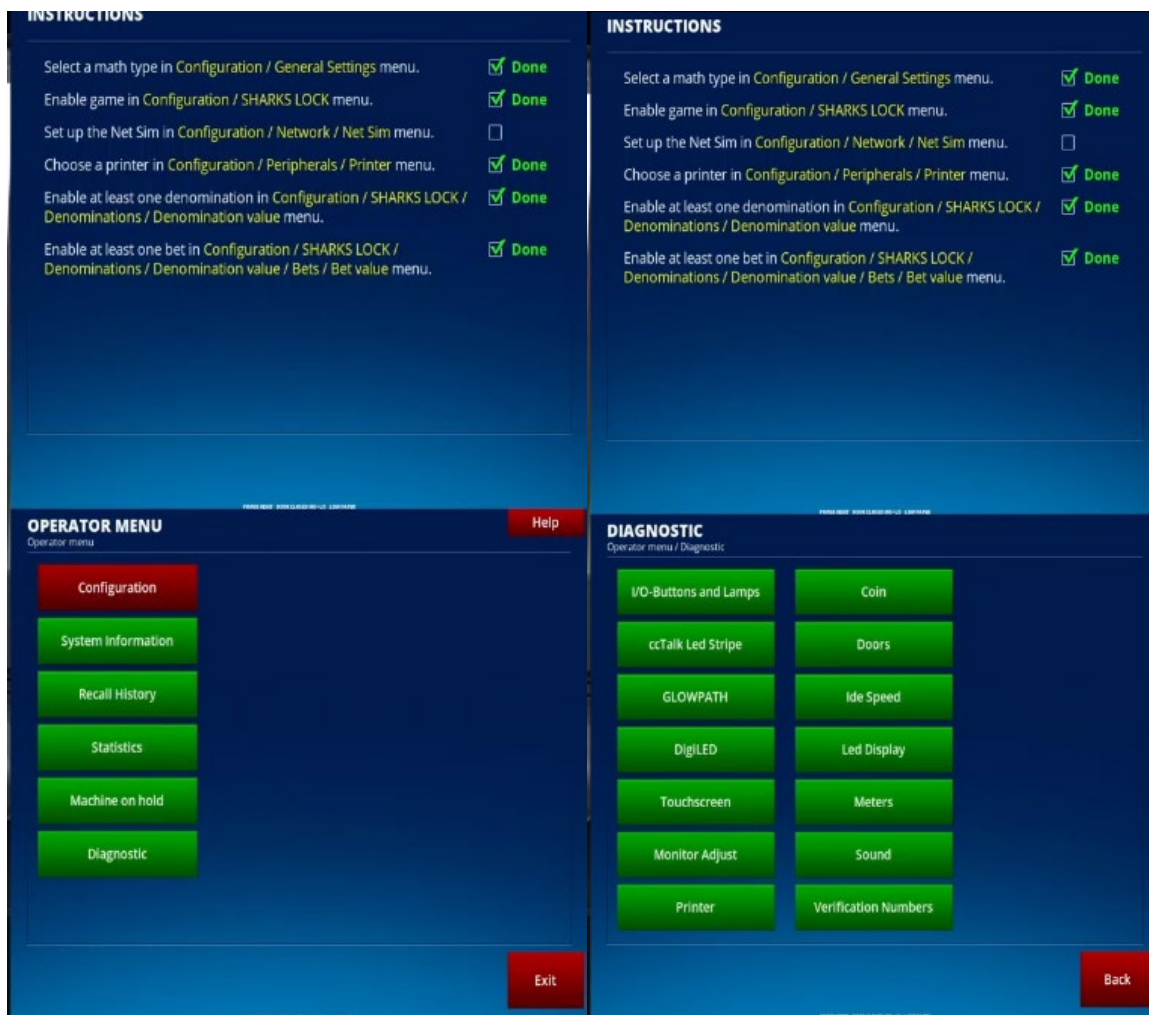



Contact Us

If you have any questions, comments, or feedback,

Head office

6355 W Maule Ave Suite 120,
Las Vegas, NV 89118

Phone : 1-800-720-5155

General inquiries : info@bluberi.com



© 2024 Bluberi Gaming Canada Inc.

All rights reserved. No part of this document may be reproduced, in any form or by any means, without prior written authorization from Bluberi Gaming Canada Inc.

The information contained in this document represents the current view of Bluberi on the issues discussed as of the date of publication. Because Bluberi must respond to changing market conditions, the comprised information should not be interpreted as a commitment on the part of Bluberi, and Bluberi does not guarantee the accuracy of any presented information.

This document is for informational purposes only. BLUBERI MAKES NO WARRANTIES, EXPRESSED OR IMPLIED, IN THIS DOCUMENT.

Other product and company names mentioned herein may be the trademarks of their respective owners.