

BUTTON PANEL REPLACEMENT

Novus B49 3.0

Version

1.0.3

Department

TEC-EL-04229

Creation date

2024-04-24

Audience

Field Service Technicians



Version History

Version	Department	Initials	Date	Comments
1.0.0	Field Service	BC	4/24/2024	First Draft
1.0.1	Field Service	BC	6/20/2024	Fixed Images
1.0.3	Field Service	BC	6/26/2024	Added service link

Contents

Version History	2
1. Introduction.....	4
2. Material Required.....	4
3. Tools Required	4
4. Removal	4
5. Installation	9
Contact Us.....	13

1. Introduction

This document intends to guide a Bluberi field service technician or casino slot technician on how to install/replace a Novus B49 3.0 button panel.

2. Material Required

To replace a broken button panel, you will need a replacement panel with frosted diffusers. The part number is 120702-FS.

3. Tools Required

- 5/16 socket connected to a ratchet or impact setup.
- Flat head screwdriver

4. Removal

4.1. Open The Main Door

- Turn the main door lock clockwise to unlock it.
- Once unlocked, pull on the main door handle to open it partially.

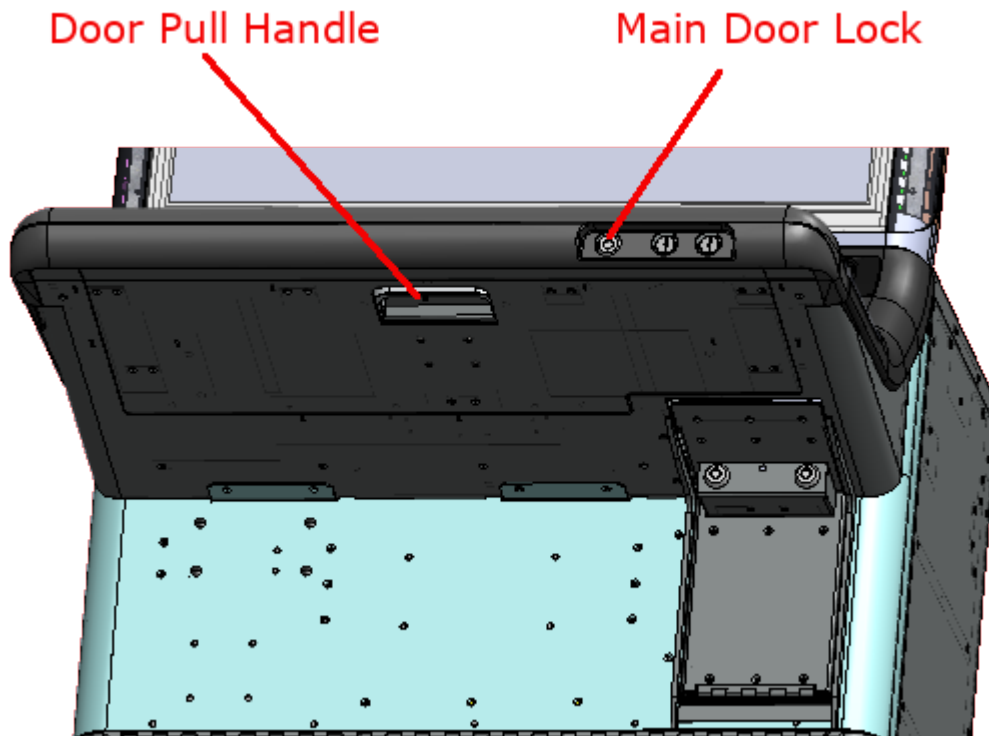

- To fully open the main door, push the door stop bracket inward towards the inside of the machine while lifting the door up a few inches. Once the bracket is pushed in, lower the main door completely.

Door Stop Bracket

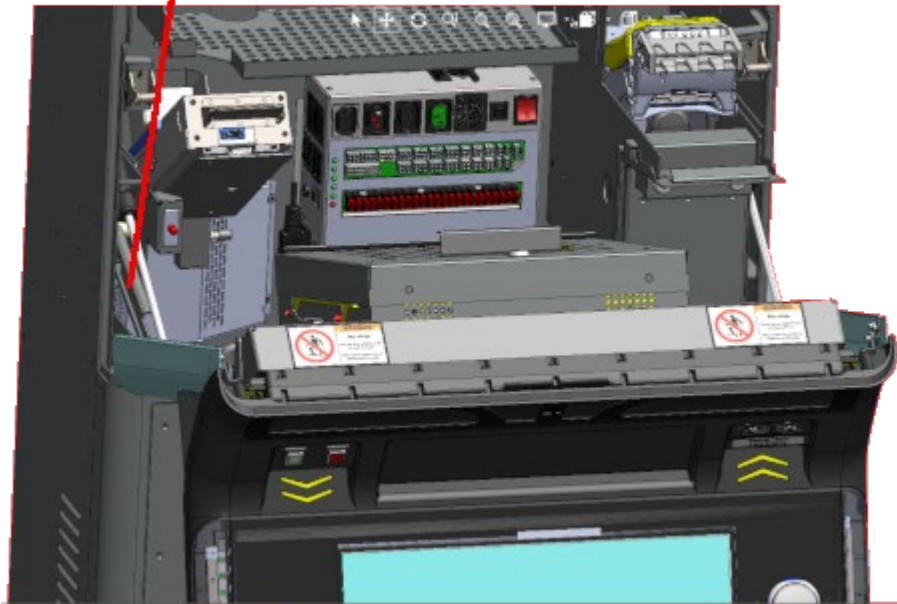

4.2. Power Down the Machine

- Power down the machine by switching off the power switch on the Power Distribution Unit

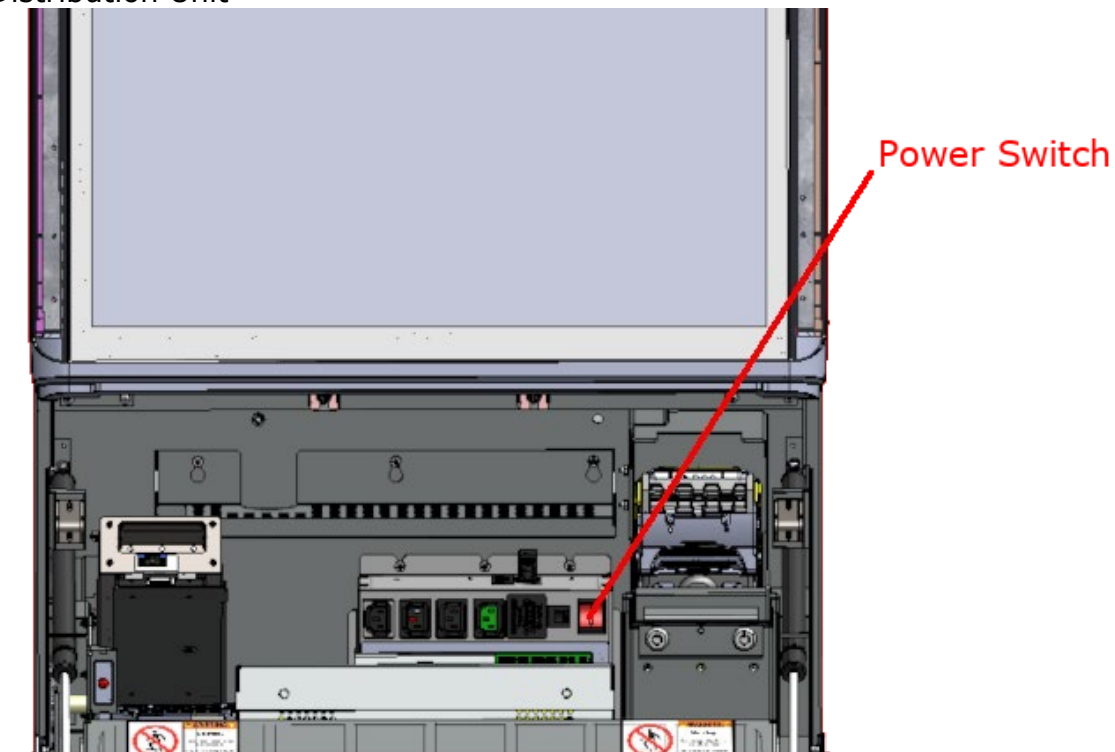

4.3. Raise The CPU Assembly Housing

- Unlock the CPU housing by pushing the spring lock outward, away from the cabinet.
- Once unlocked, lift the CPU housing to raise the CPU assembly.

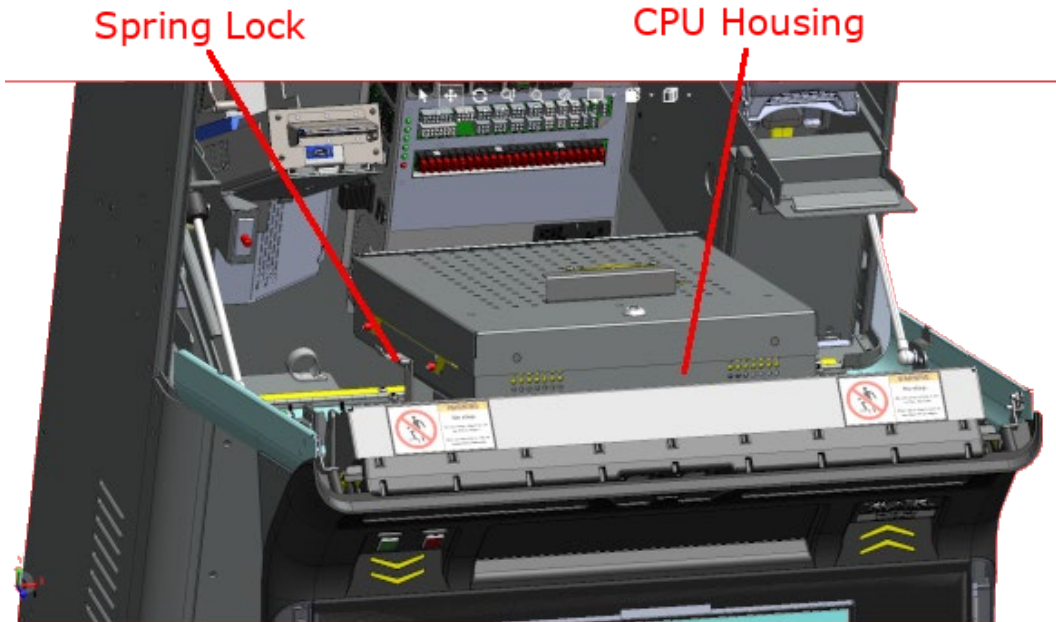

4.4. Remove The Button Panel Cover

- Unlock the button panel cover by turning the lock counterclockwise with a flathead screwdriver.

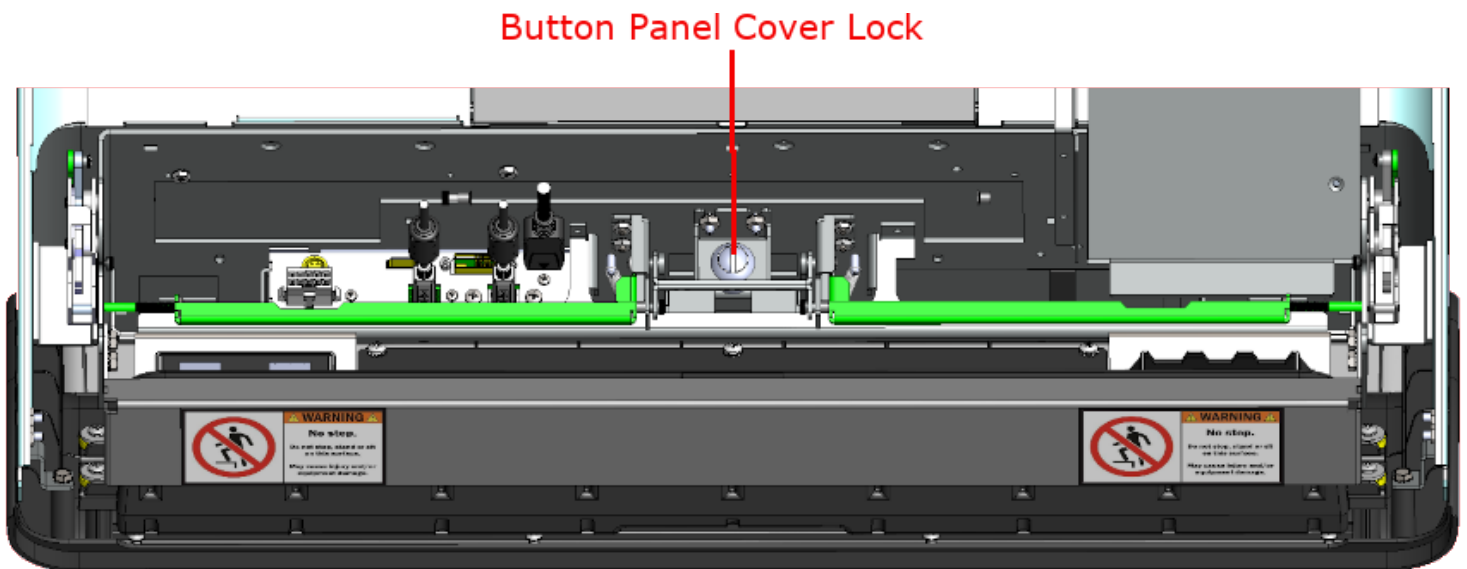

- Once unlocked, remove the button panel cover by pulling it off from the bottom of the main door.

Button Panel Cover

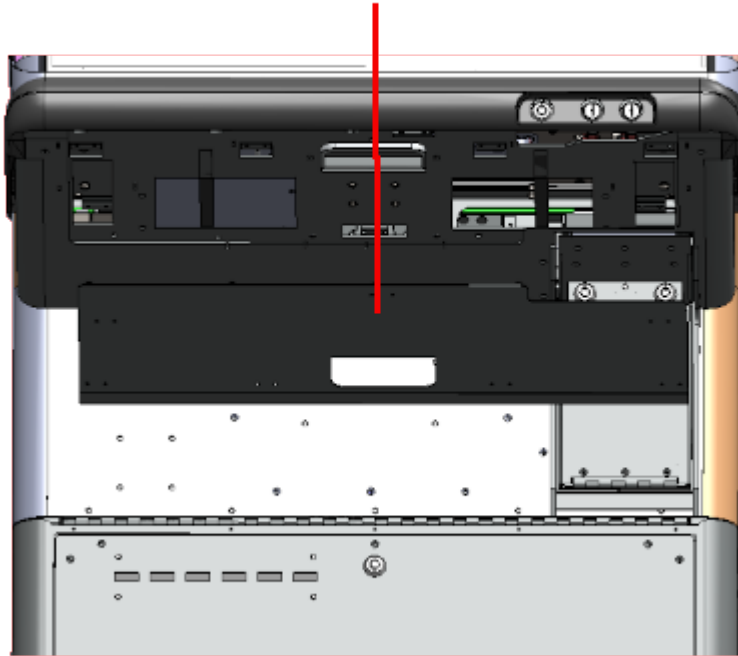

4.5. Remove The Button Panel

- Remove the four 5/16 bolts securing the button panel.

Button Panel Bolt Locations

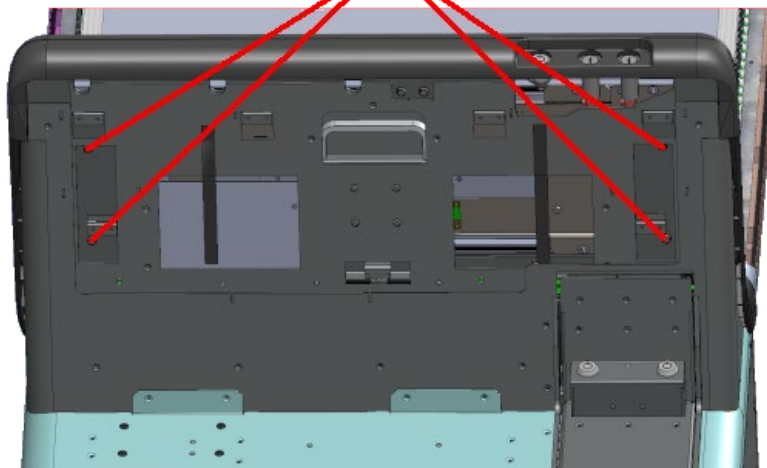

- Unplug the power, touch, digi-LED, and DisplayPort cables.

Power Touch USB-B Display Port Digi-LED-USB-B

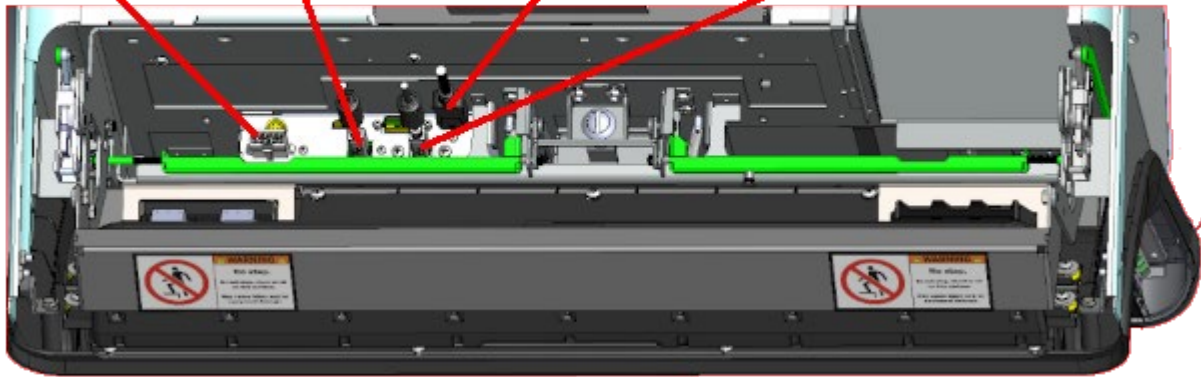

- Carefully lift out the button panel.

Button Panel Assembly

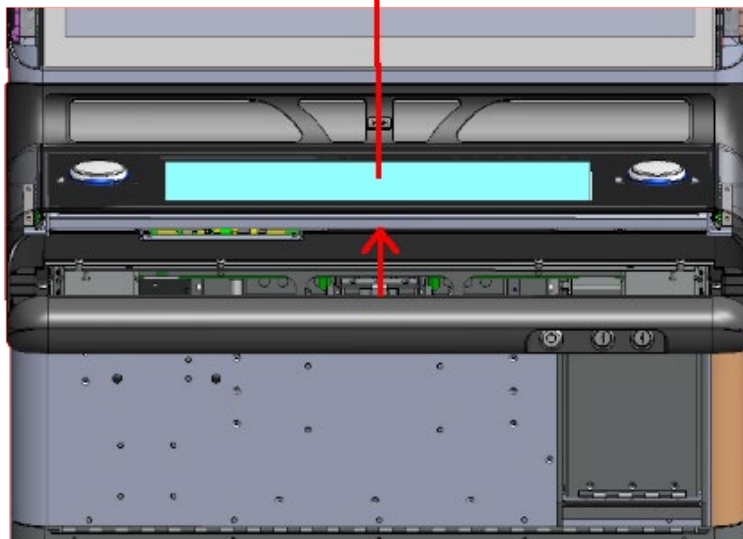

5. Installation

5.1. Install The Replacement Button Panel

- Place the new button panel into the main door housing.

Button Panel Assembly

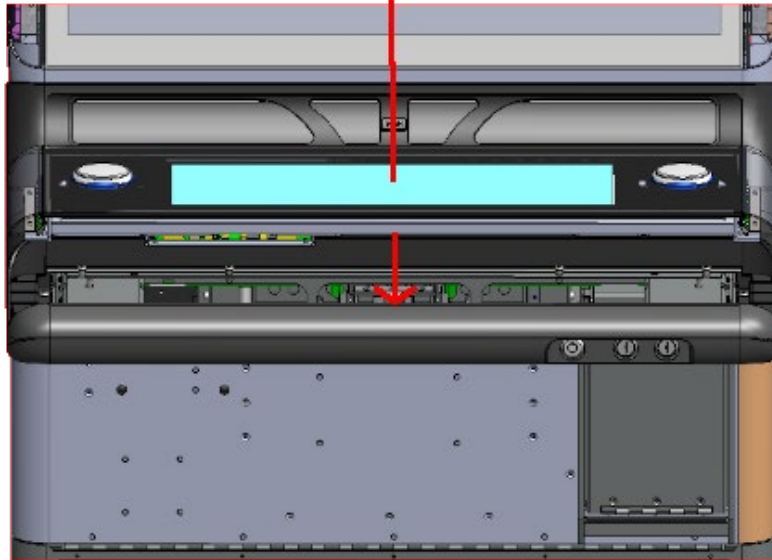

- Secure the button panel by reinstalling the four 5/16 bolts.

Button Panel Bolt Locations

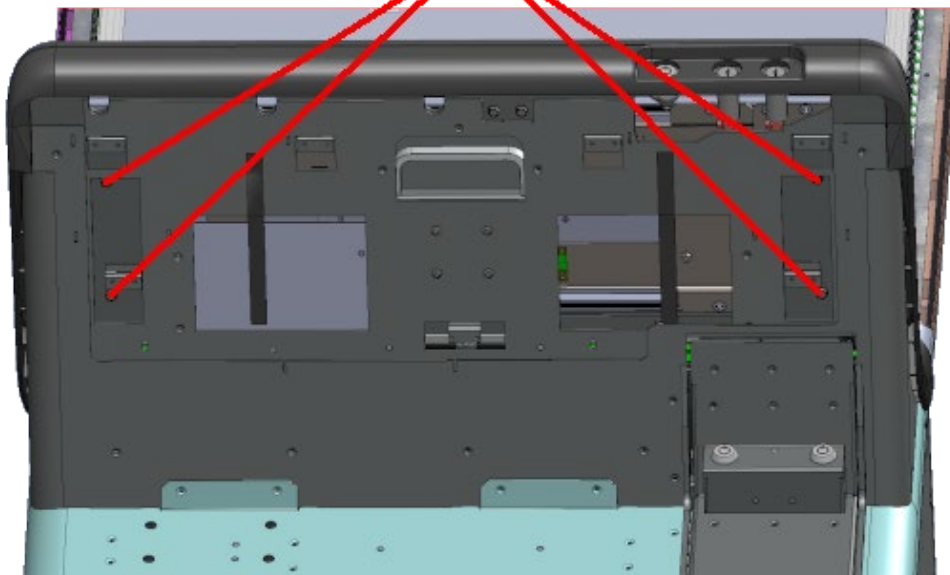

- Connect the power, touch, digi-LED, and DisplayPort cables.

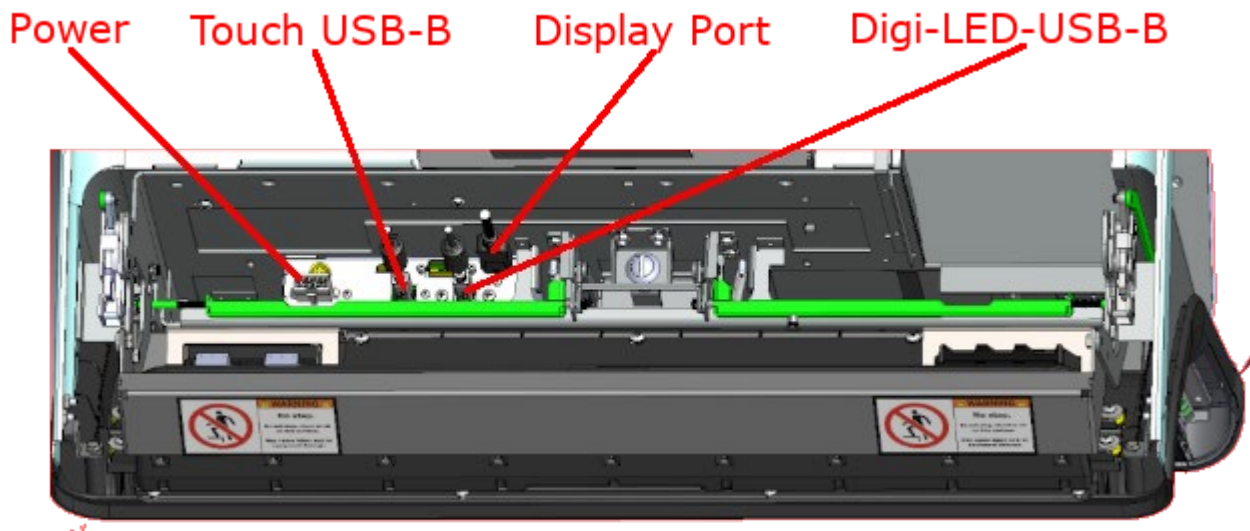

5.2. Install the Button Panel Cover

- Insert the deck door stop into the square hole where the lock is located.

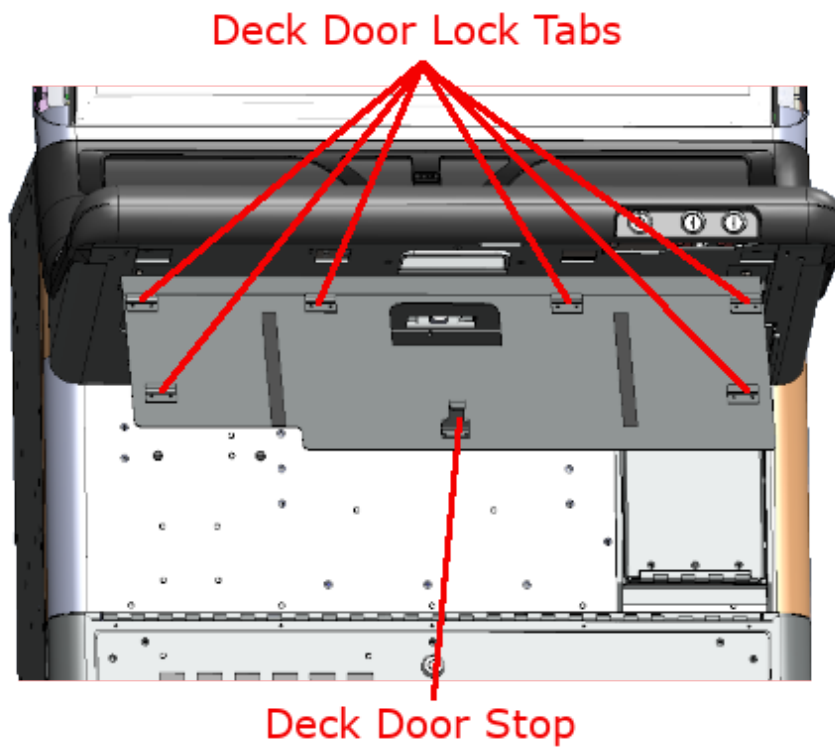

- Slide the cover upward to allow the six door lock tabs to slide into place.
- While holding the panel in place, use a flathead screwdriver to turn the button panel cover lock clockwise to secure it.

Button Panel Cover Lock

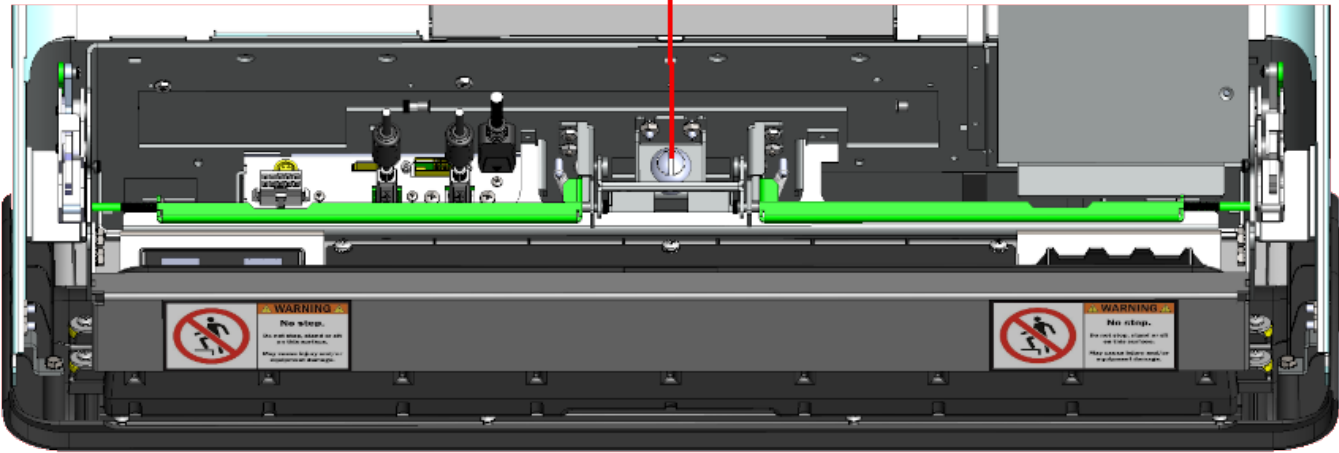

5.3. Close The Cabinet Doors

- Lower the CPU housing and secure it using the spring lock.
- Close the main door firmly.

Spring Lock

CPU Housing

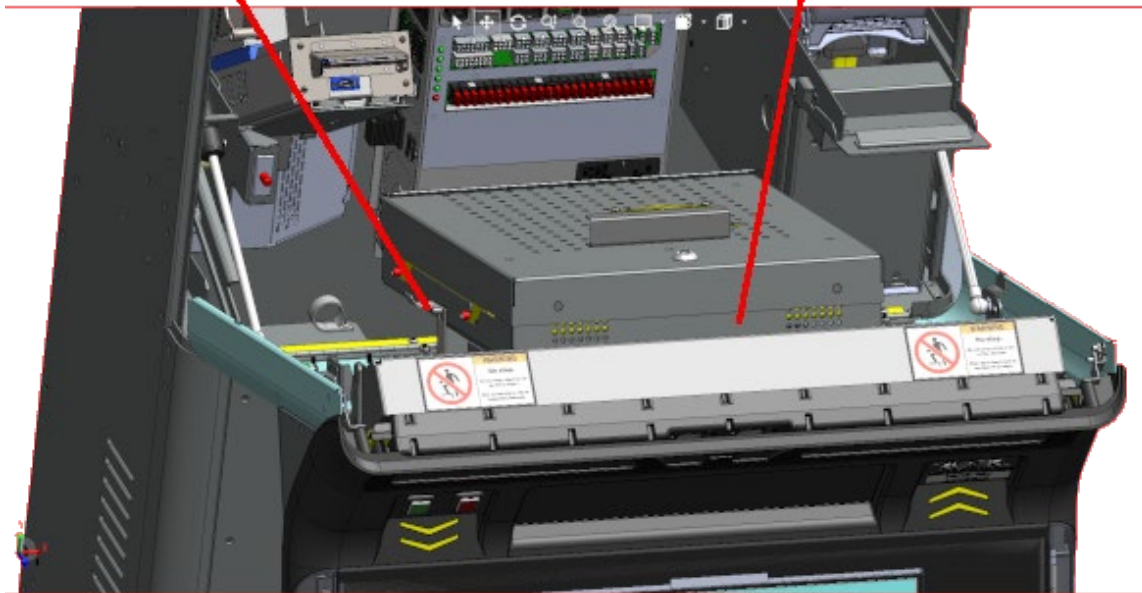

5.4. Testing

- Test the touch, buttons, and Digi-LEDs via the diagnostic menu.
- Once testing is complete with no issues, the installation is complete.



Contact Us

If you have any question, comment or feedback, please use the contact details provided below.

Main office

6355 W Maule Ave Suite 120

Las Vegas, NV 89118

United States

Phone : 1-800-720-5155

General inquiries : info@bluberi.com



© 2024 Bluberi Gaming Canada Inc.

All rights reserved. No part of this document may be reproduced, in any form or by any means, without prior written authorization from Bluberi Gaming Canada Inc.

The information contained in this document represents the current view of Bluberi on the issues discussed as of the date of publication. Because Bluberi must respond to changing market conditions, the comprised information should not be interpreted as a commitment on the part of Bluberi, and Bluberi does not guarantee the accuracy of any presented information.

This document is for informational purposes only. BLUBERI MAKES NO WARRANTIES, EXPRESSED OR IMPLIED, IN THIS DOCUMENT.

Other product and company names mentioned herein may be the trademarks of their respective owners.